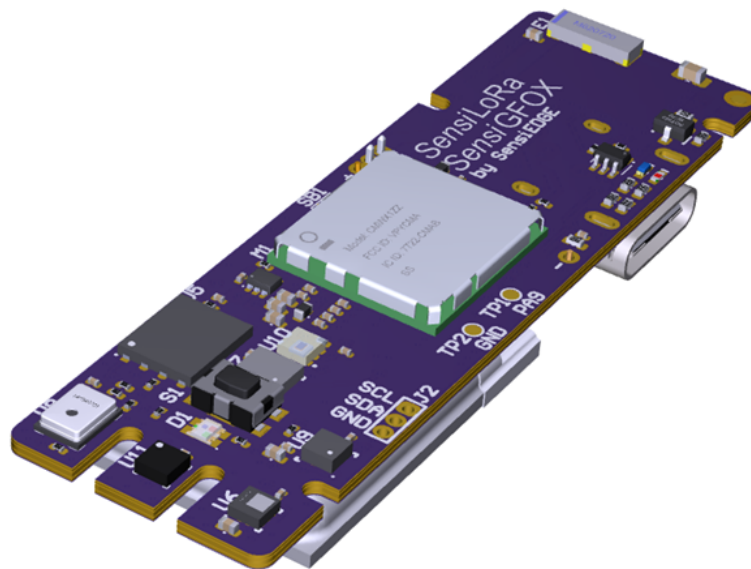


# *SensiLoRa 2.0* Getting Started



---

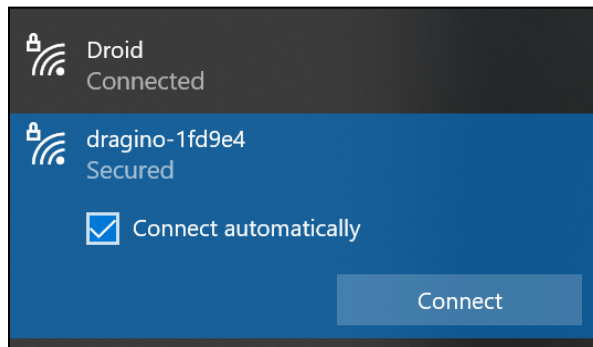
<b>1 Config Dragino Pico Station</b>	<b>3</b>
1.1 Connect to Dragino	3
1.2 Configuration LoRa	4
1.3 Configuration LORIoT	5
<b>2 Registration in LORIoT</b>	<b>7</b>
2.1 Registration in Server	7
2.2 Register a gateway	9
2.3 Add a Device	12
2.4 Loriot Uplink	15
<b>3 LORIoT Integration to Thingsboard</b>	<b>17</b>
3.1 Overview	17
3.2 Registration	17
3.3 Import a Data Converter	17
3.4. Create Integration	19
3.5 Device	24
3.6 Dashboard	26
3.6.1 Overview	26
3.6.2 Add Dashboard	26
3.6.3 Add Entity aliases	27
3.6.4 Add Temperature widget	30
3.6.5 Import Dashboard	34
<b>4 STM32CubeMonitor</b>	<b>36</b>
4.1 Install STM32CubeMonitor	36
4.2 Import project	37
4.3 Configuration Loriot Uplink	39
4.4 Dashboard	42
<b>5 Flashing SensiLoRa 2.0</b>	<b>45</b>
5.1 Install STM32CubeProgrammer	45
5.2 Flashing with SensiEdge Basic Debugger	46
5.3 Flashing via USB Type-c	50
<b>6 Battery power</b>	<b>54</b>
6.1 Overview	54
<b>7 Turn on/off SensiLoRa 2.0</b>	<b>55</b>
7.1 Turn on board	55
<b>8 External pins</b>	<b>57</b>
8.1 Overview	57
8.2 External I2C	57
8.3 Debug information PA9 pin	58

# 1 Config Dragino Pico Station

## 1.1 Connect to Dragino

1. Connect the antenna, and network cable and turn on the device. After starting the device, it should be defined on the Wi-Fi network as "**dragino-xxxxxx**" (Figure 1). When the device is found, we connect to it and enter the default password: "**dragino+dragino**".

**Figure 1. Wi-Fi network**

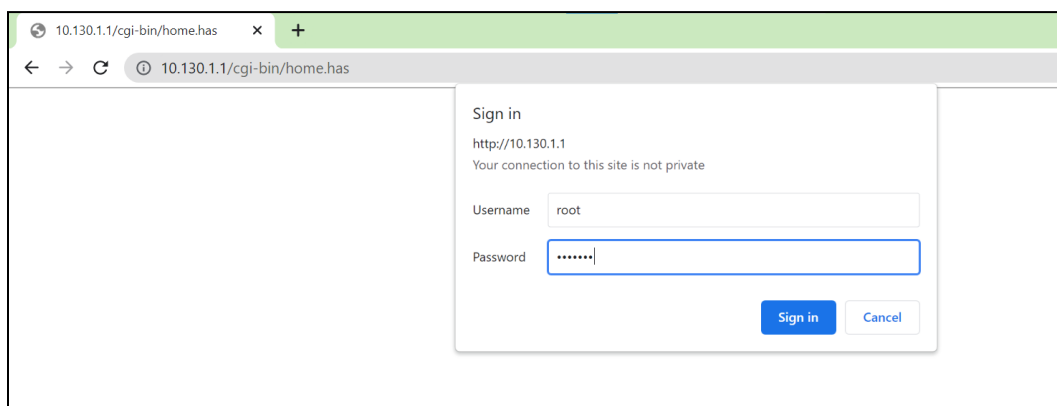


2. When connected to the device, open the browser and enter the address: <http://10.130.1.1/> and enter (Figure 2):

**User Name:** root

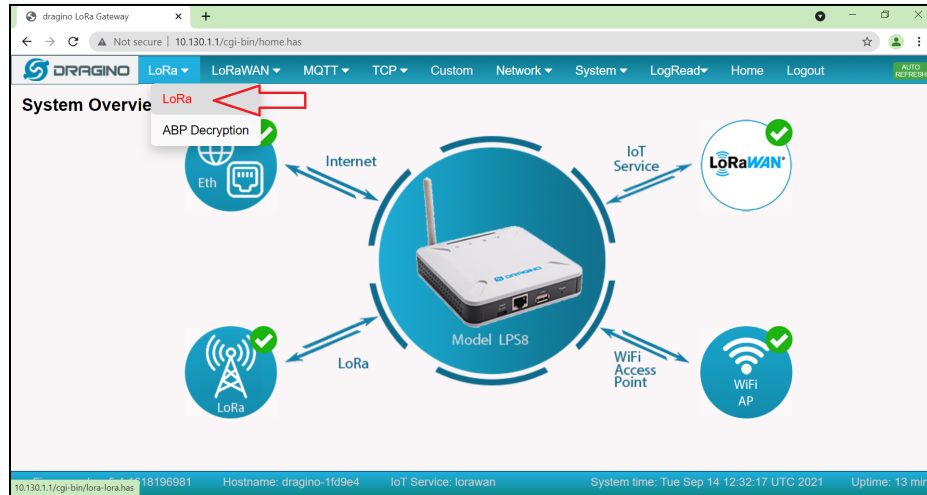
**Password:** dragino

**Figure 2. Site**



3. Go to network settings LoRa (Figure 3).

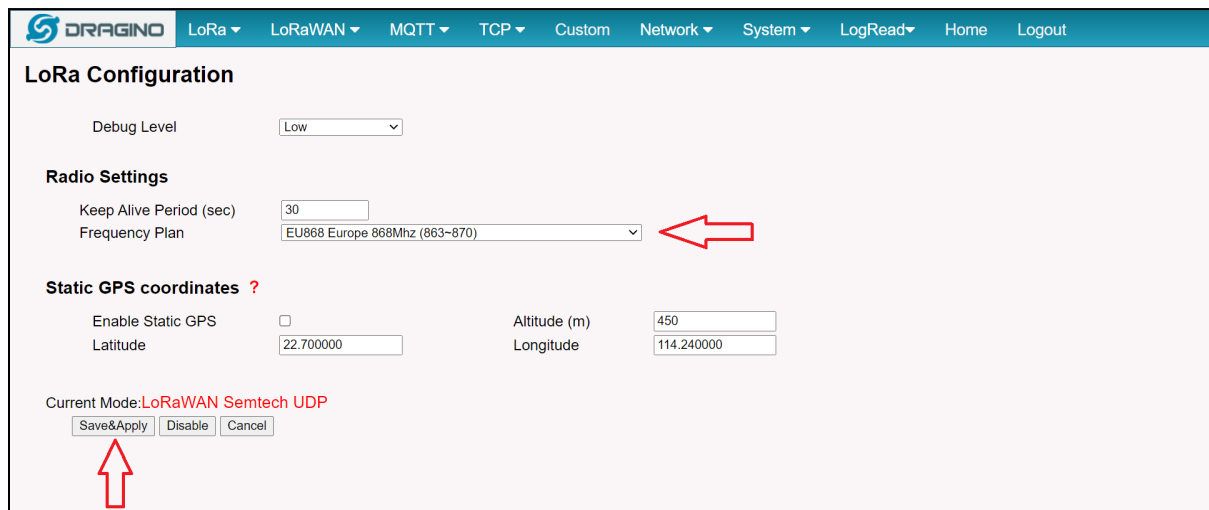
**Figure 3. Go to LoRa settings**



## 1.2 Configuration LoRa

1. In LoRa Configuration select the desired frequency (EU868 or US915) and click on **Save&Apply** (Figure 4).

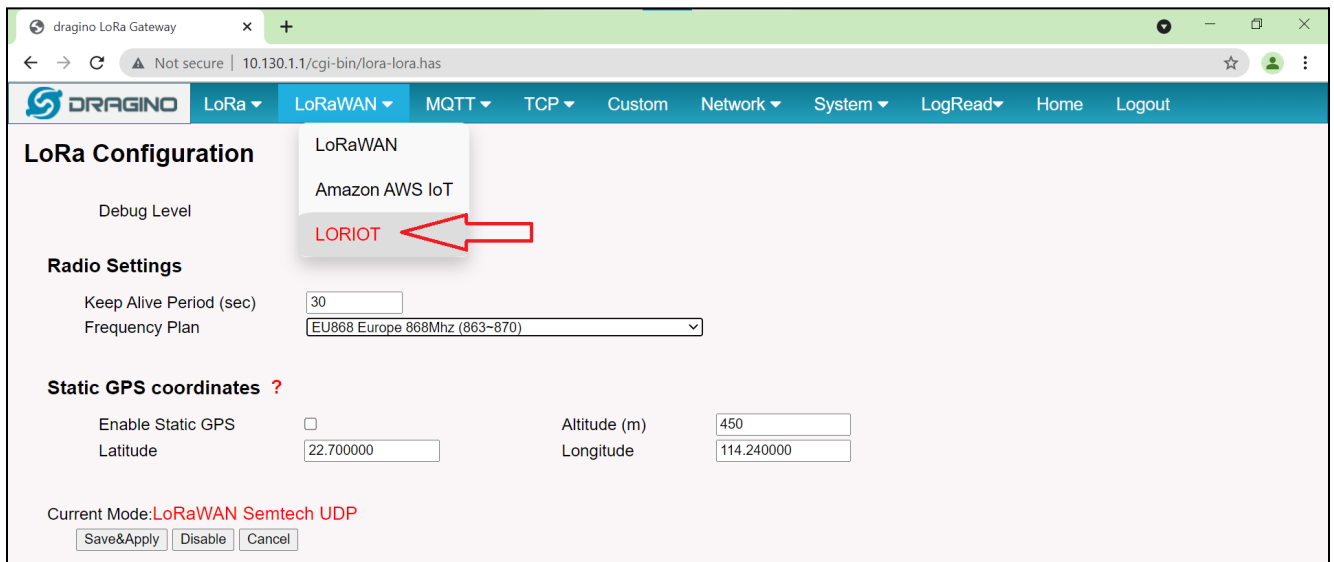
**Figure 4. Configuration Lora**



### 1.3 Configuration LORIIOT

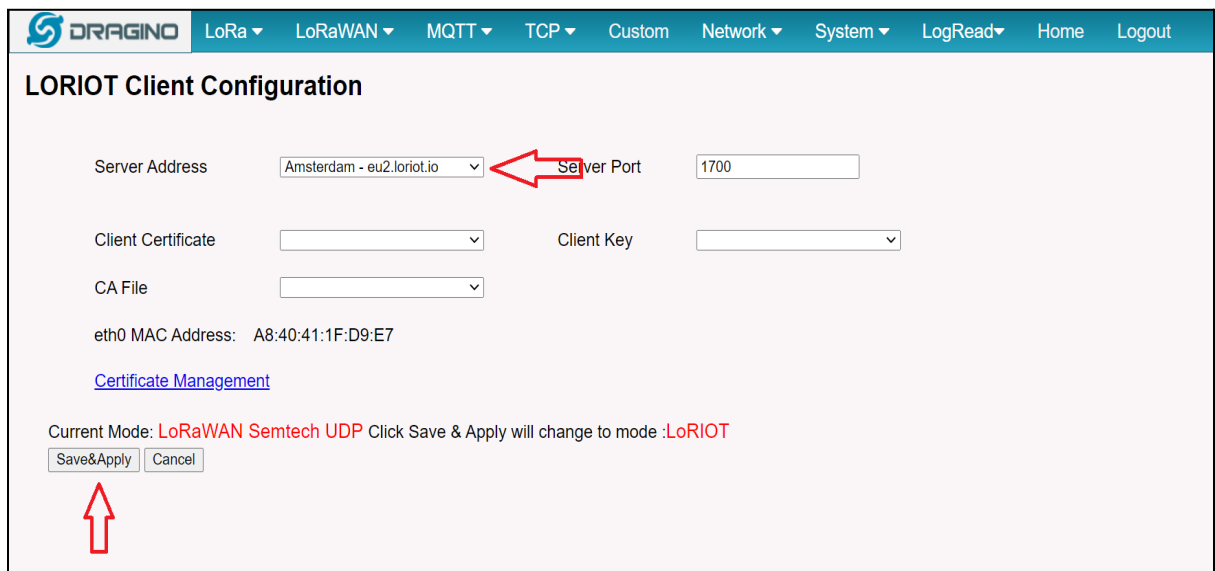
1. Go to configuration **LORIIOT** (Figure 5).

**Figure 5. Go to Loriot settings**



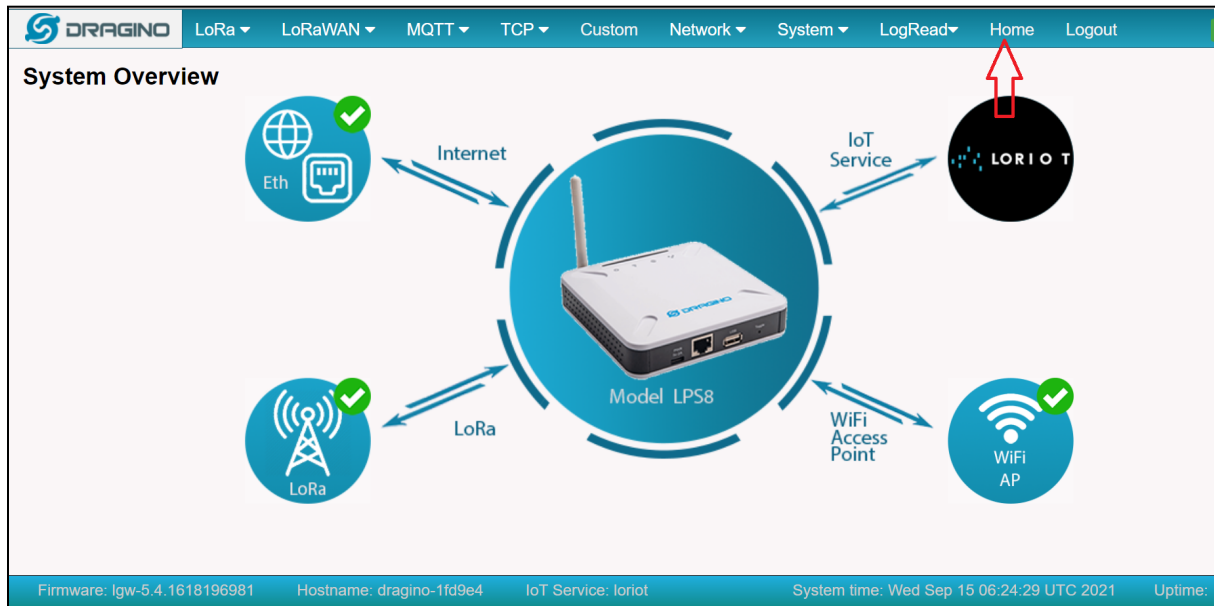
2. In the configuration LORIIOT, select the desired server (example: **Amsterdam - eu2.loriot.io**) and click on **Save&Apply** (Figure 6).

**Figure 6. Configuration Loriot**



3. After configuring the LORIOT, go to the **Home** tab and you should see green checkmarks as in the picture, this means that everything is working (Figure 7).

Figure 7. Home page

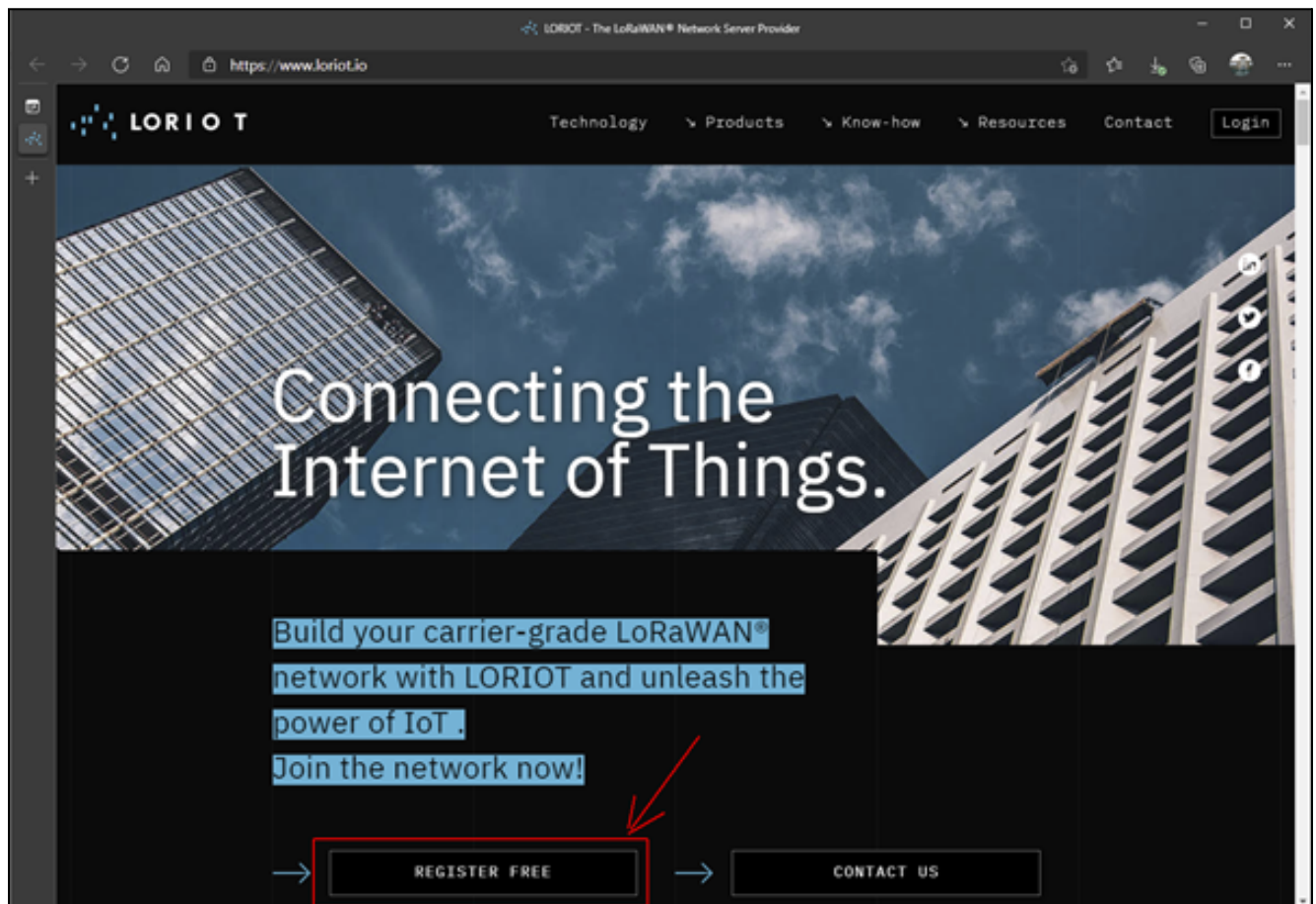


## 2 Registration in LORIOT

### 2.1 Registration in Server

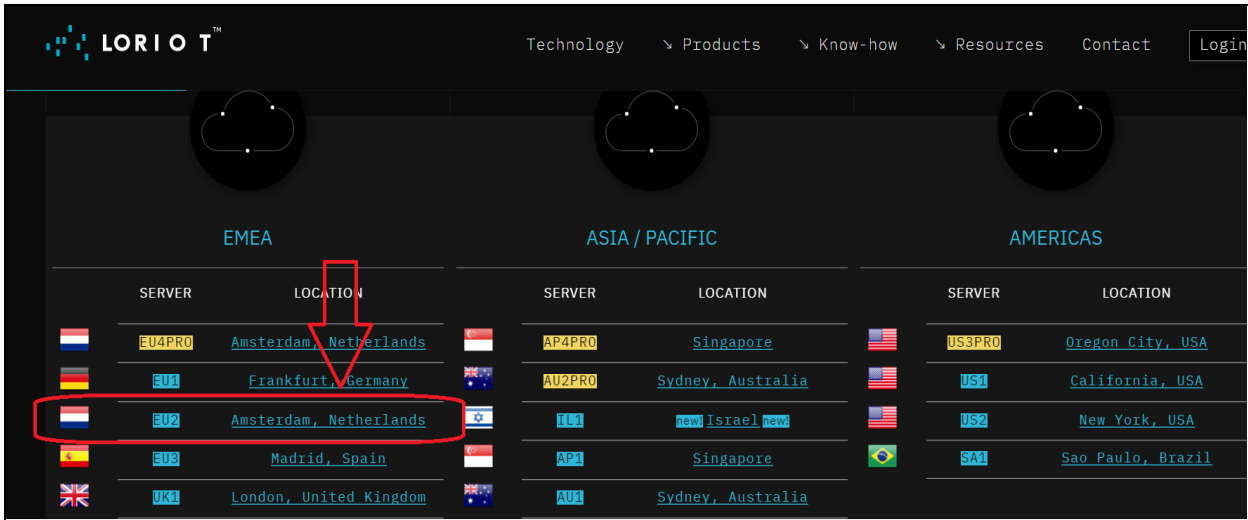
1. Go to <https://www.loriot.io/> and press **REGISTER FREE** (Figure 8).

Figure 8. LORIOT site



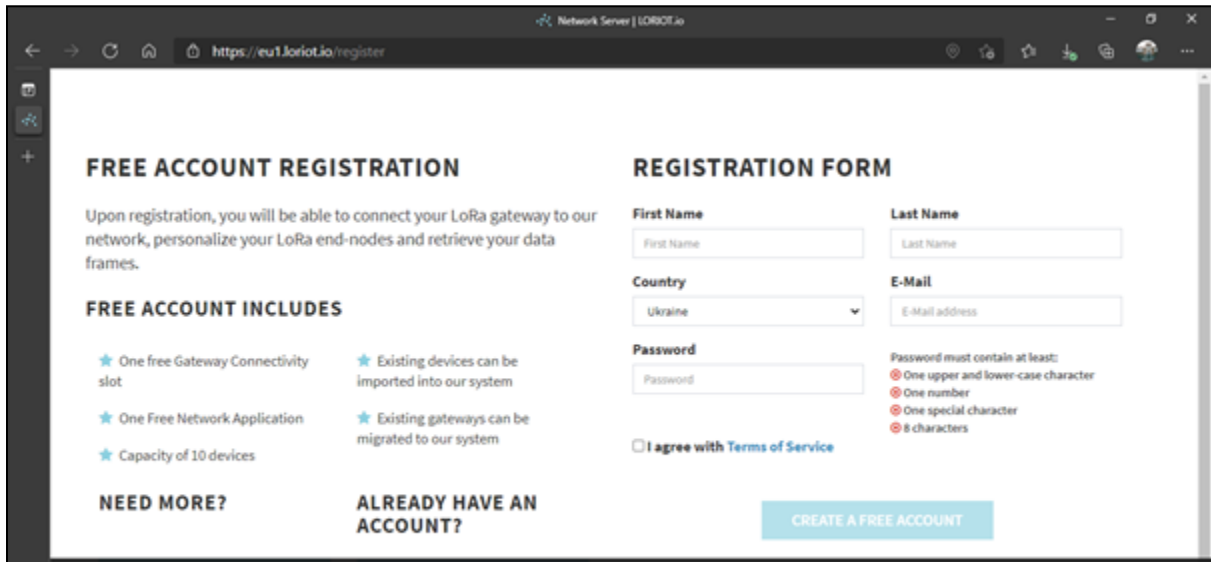
2. Select server **EU2 Amsterdam, Netherlands** (Figure 9).

**Figure 9. Select server**



3. Input all data and press the button **CREATE A FREE ACCOUNT** (Figure 10).

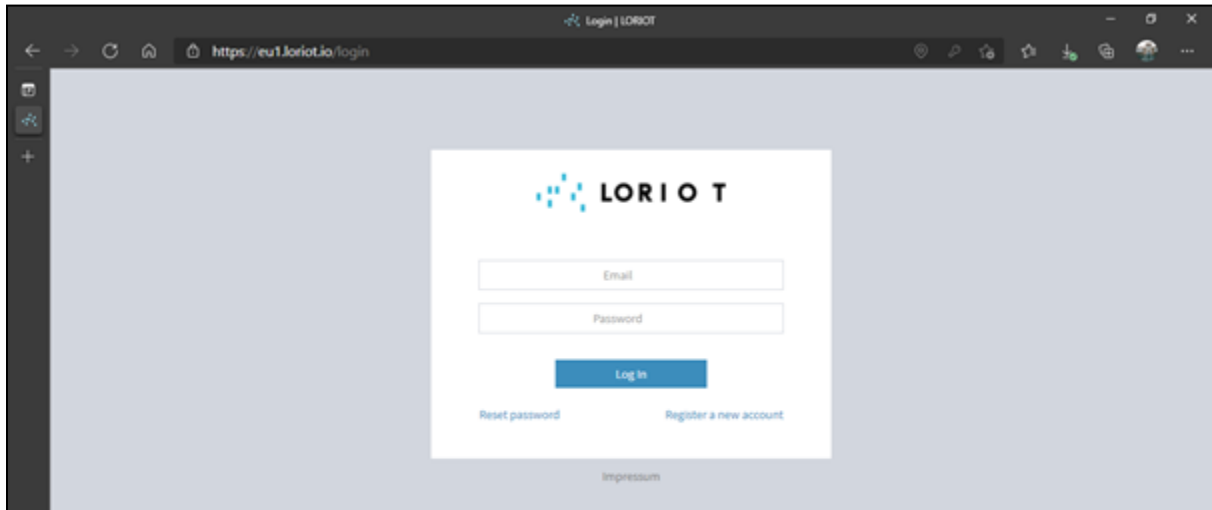
**Figure 10. Create account**



4. After confirmation via email enter the site (Figure 11).



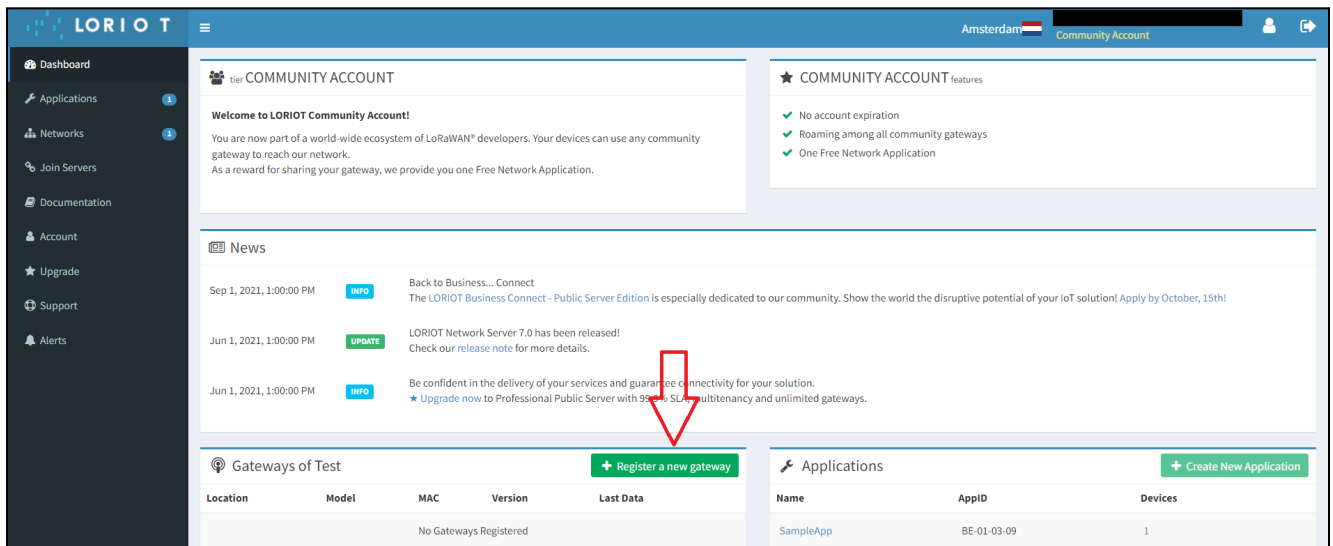
**Figure 11. Login to server**



## 2.2 Register a gateway

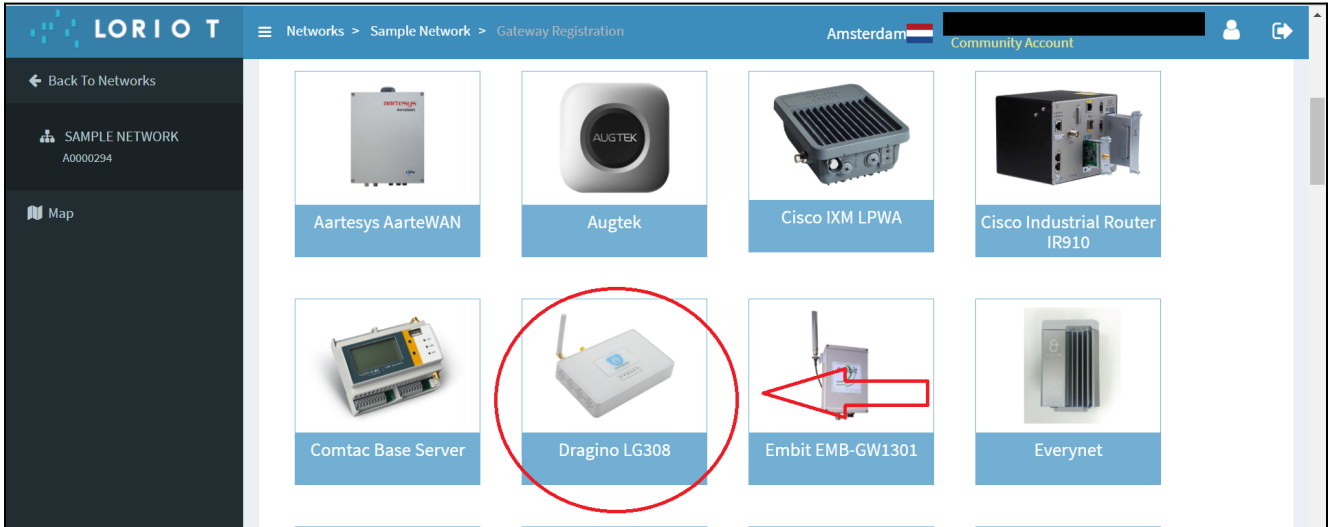
1. Add Gateway. Press the button **Register a new gateway** (Figure 12).

**Figure 12. Register gateway**



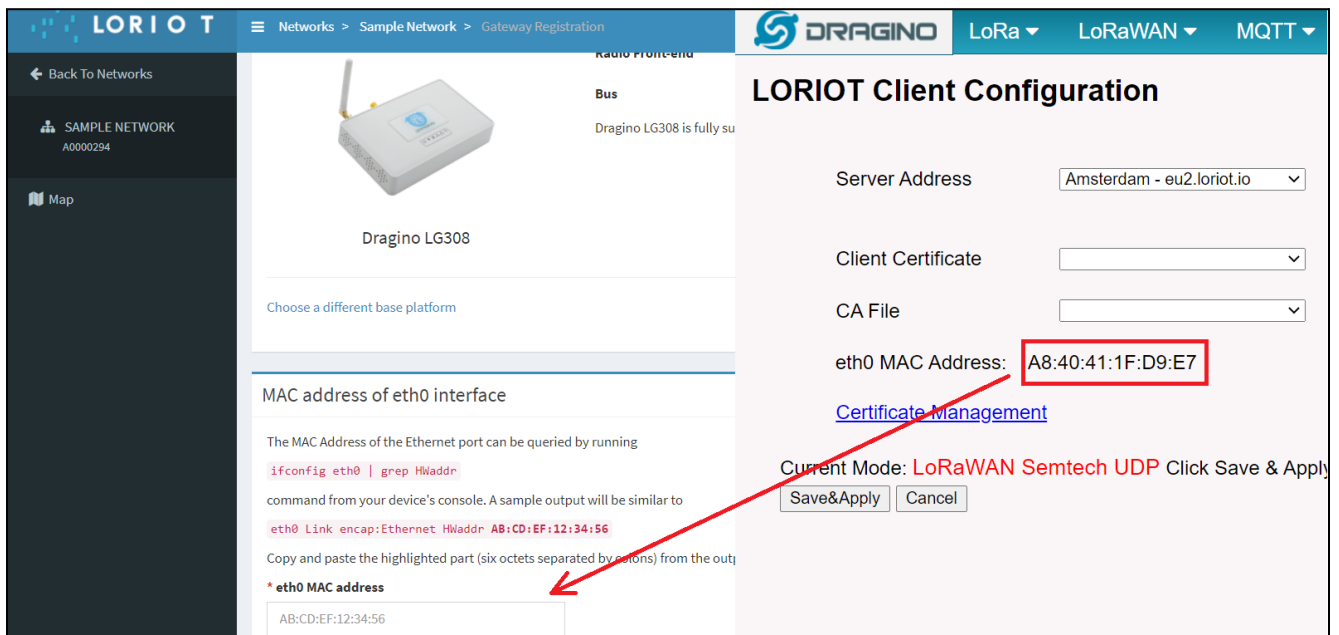
2. Scroll down and select **Dragino LG308** if you use Dragino pico station LPS8 or LG308 (Figure 13).

**Figure 13. Add the Dragino**



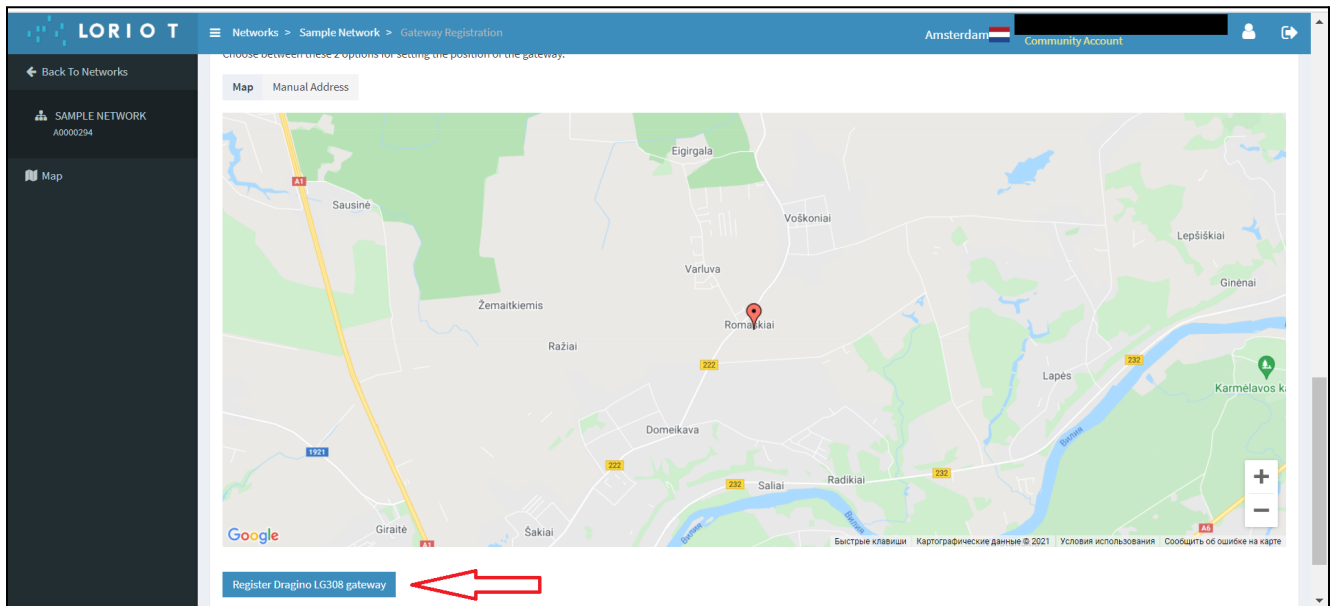
3. Scroll a little below and you will see a field for entering the device address (Figure 14). If a Dragoni Pico Station is used, then the Eth0 Mac address can be taken on a *web-based GUI Dragino website* in LORIoT Client Configuration [1.3 Configuration LORIoT](#).

**Figure 14. Eth0 Mac address**



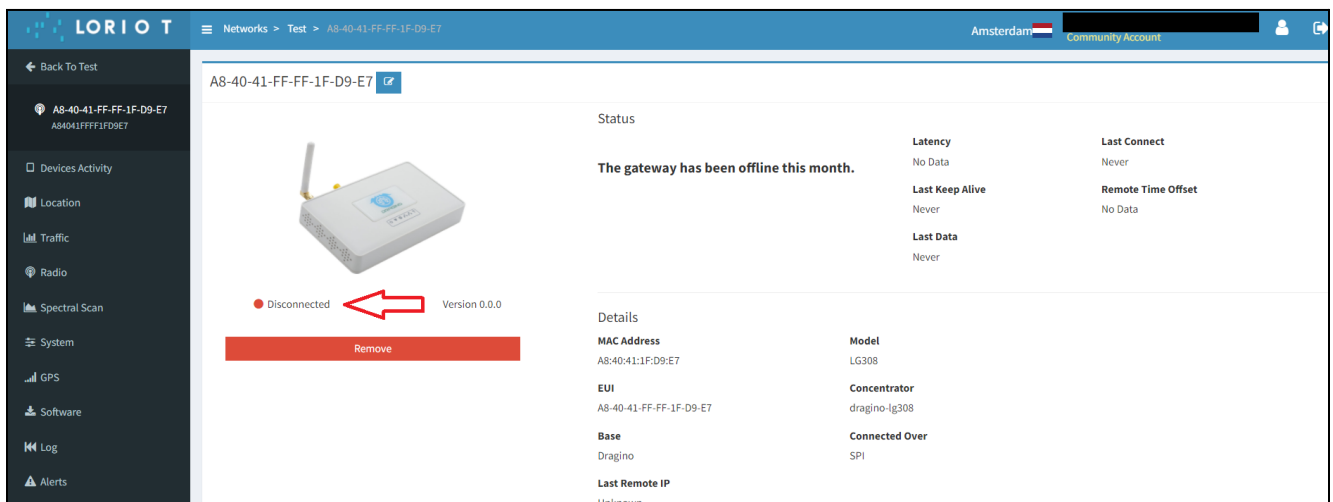
4. Scroll down and here indicates the location of the modem and then click on **Register Dragino LG308 gateway (Figure 15)**.

**Figure 15. Register Gateway**



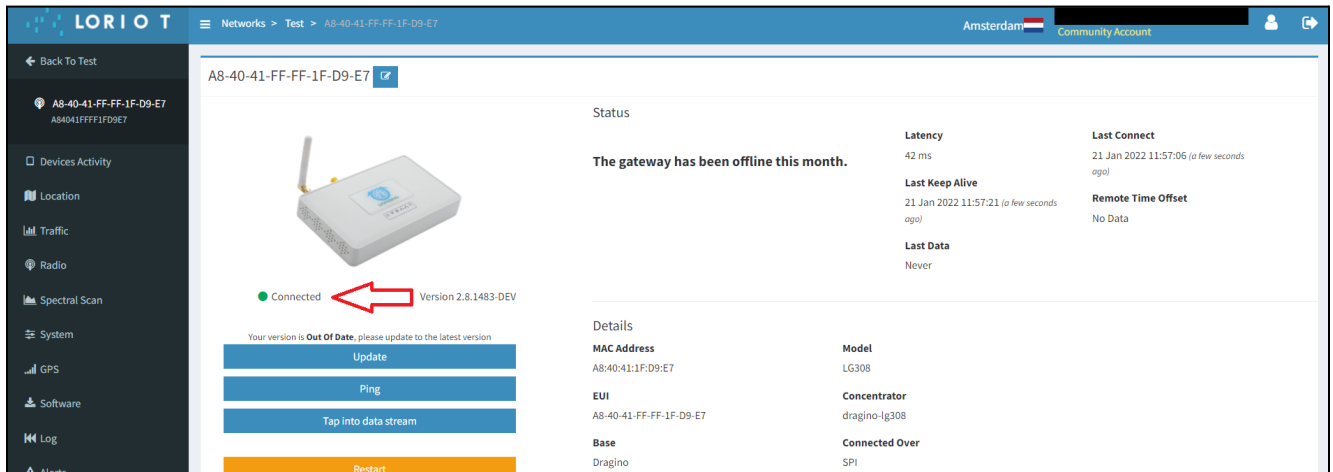
5. After registering the gateway, a page with the gateway status will appear where it will be written that the connection status is **Disconnected** (Figure 16).

**Figure 16. Gateway status**



6. To speed up the procedure for connecting the gateway to the server, you need to reboot the gateway. Need to refresh the page and wait until the gateway status changes to connected (Figure 17).

**Figure 17. Gateway Connected**



7. Go to the main page of the server by clicking on the icon **LORIoT** (Figure 18).

**Figure 18. Go to the main page**

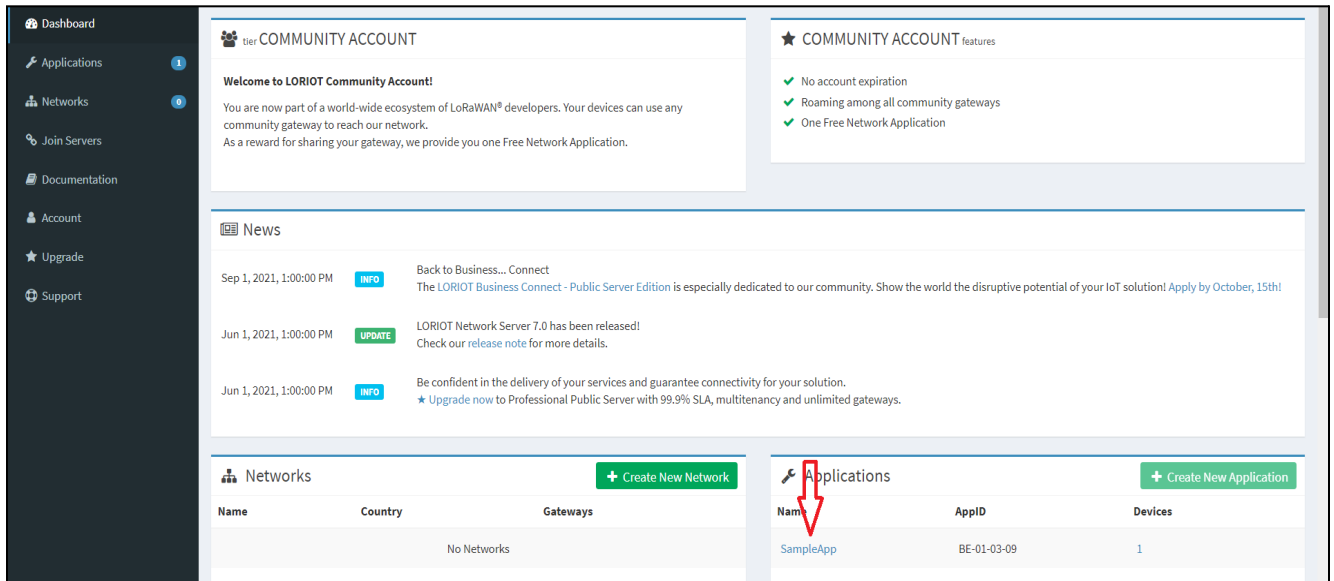


### 2.3 Add a Device

1. In order to add the SensiLoRa 2.0 device, you need now him **AppKey**, **JoinEui** and **DevEui** keys. The keys can be found using the SensiConfigurator program, download: [Download SensiConfigurator Windows](#) . Use [Getting Started SensiConfigurator](#) document section [3.2 Device Information](#).

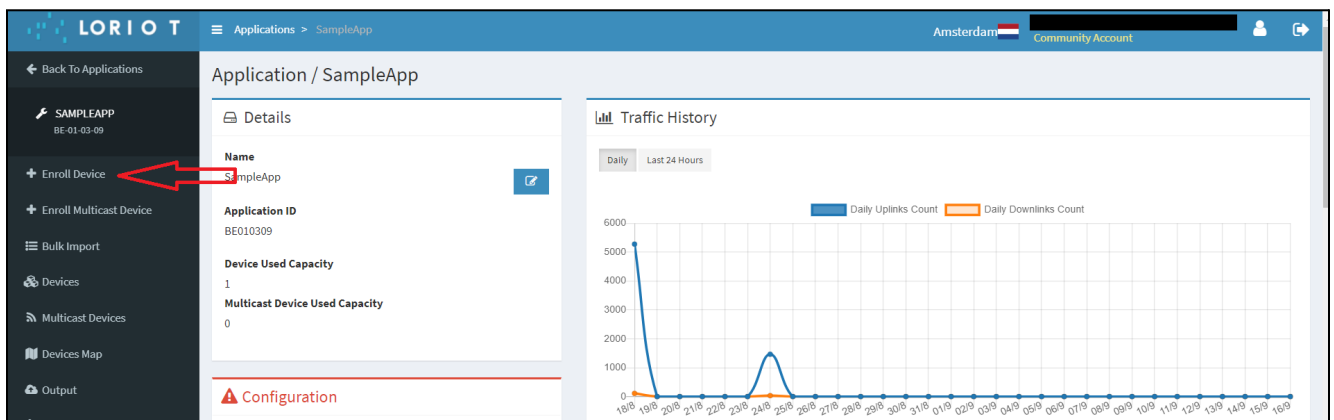
2. Add a Device. In the tab, Dashboard clicks on **SampleApp**.(Figure 19)

**Figure 19. Go to SampleApp**



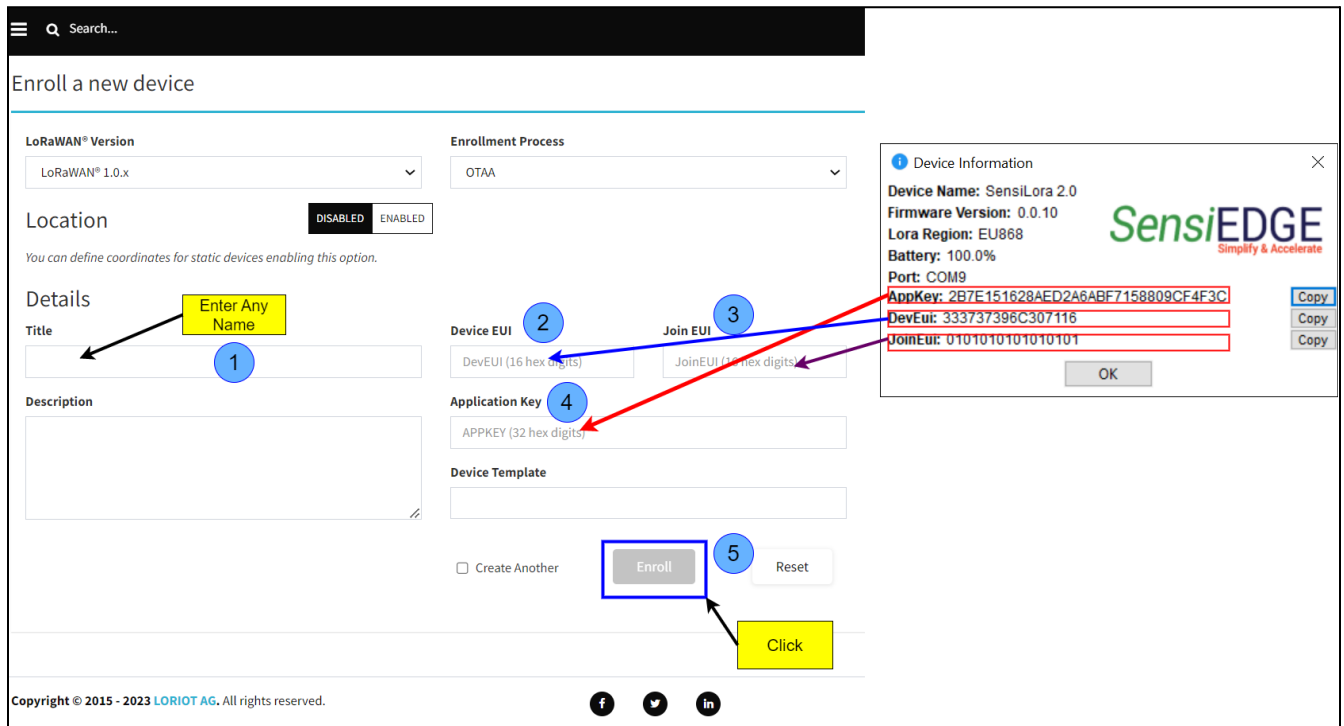
3. Click on **Enroll Device** (Figure 20).

**Figure 20. Enroll Device**



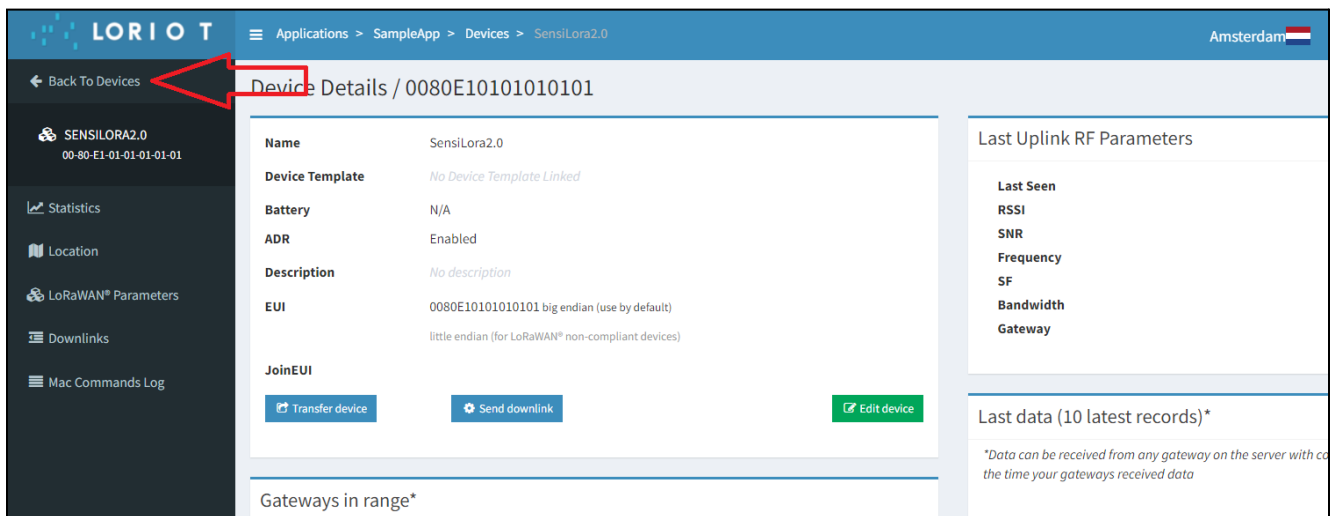
4. In the tab Enroll Device, enter any Name in **Title** (step 1), then enter **Application key** (step 4), **Device EUI** (step 2) and **Join Eui** (step 3), (this keys can be found using the SensiConfigurator program, download: [Download SensiConfigurator Windows](#) . Use [Getting Started SensiConfigurator](#) document section [3.2 Device Information](#)). Click **Enroll** (step 5) (Figure 21).

Figure 21. Add device



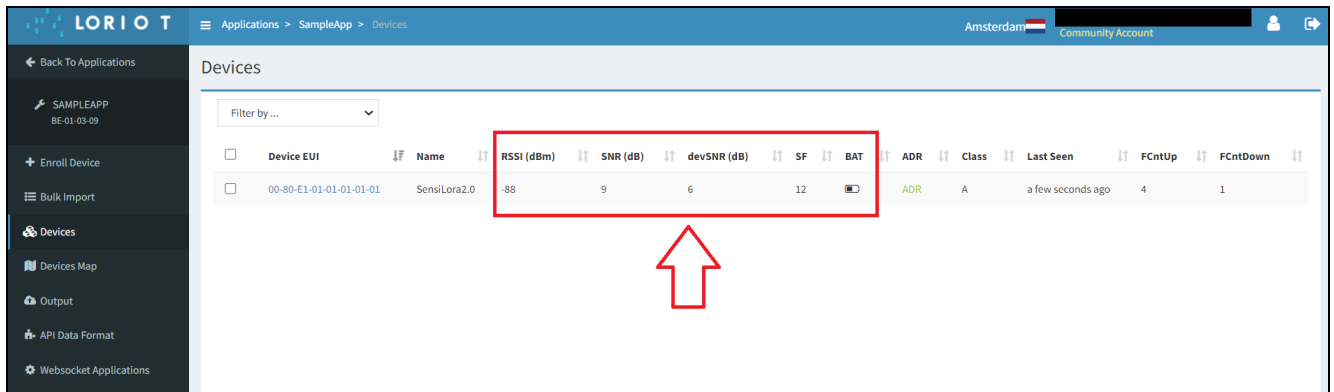
5. Go to the Devices page by clicking on the icon **Back To Devices** (Figure 22).

Figure 22. Back to Devices



6. In the **Devices** tab, you can view the addition of a device. When the added device connects to the server then we should see the value: **RSSI, SNR, devSNR, SF and BAT**, for example, in Figure 23.

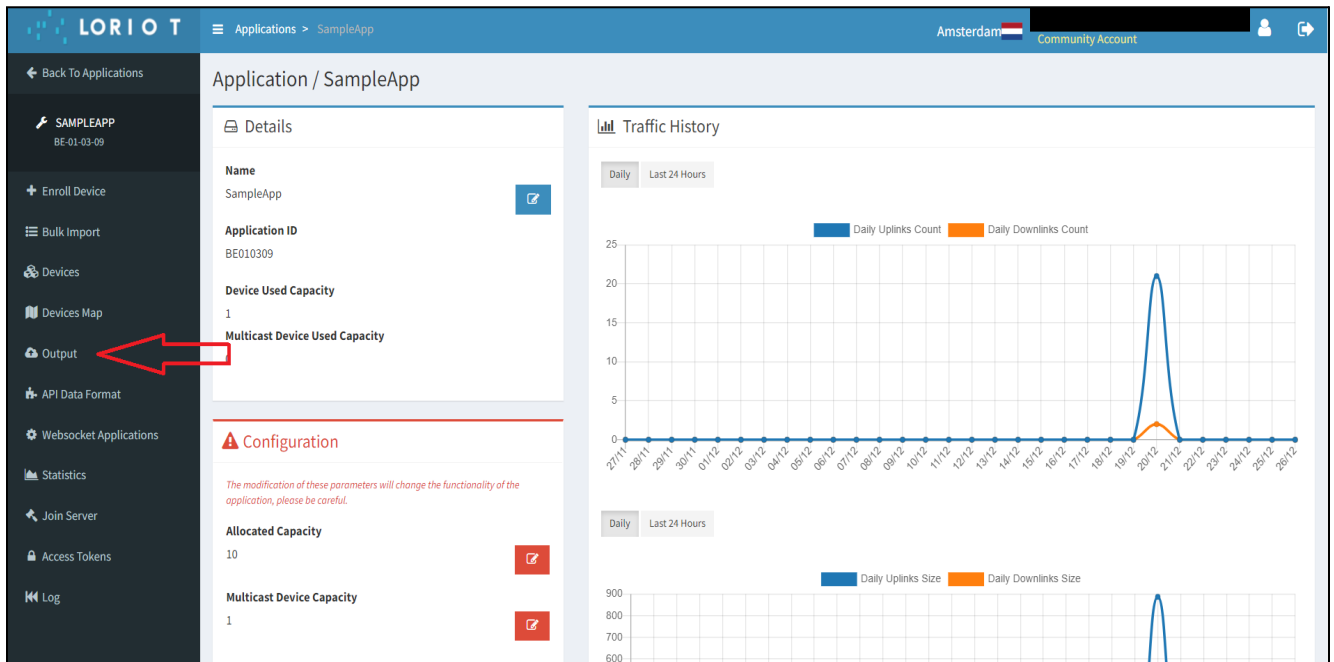
**Figure 23. Status device**



## 2.4 Lorient Uplink

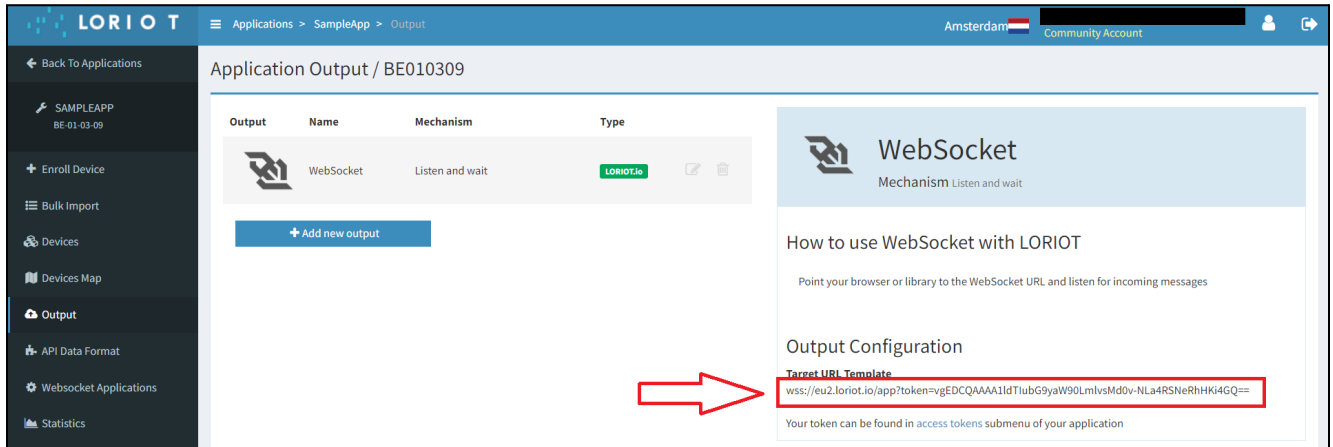
1. In the SampleApp, go to the **Output** (Figure 24).

**Figure 24. Go to Output**



2. Data output link. Example: Use the **Target URL Template**, for example, Stm32CubeMonitor (Figure 25).

**Figure 25. Target URL link**





## 3 LORIoT Integration to Thingsboard

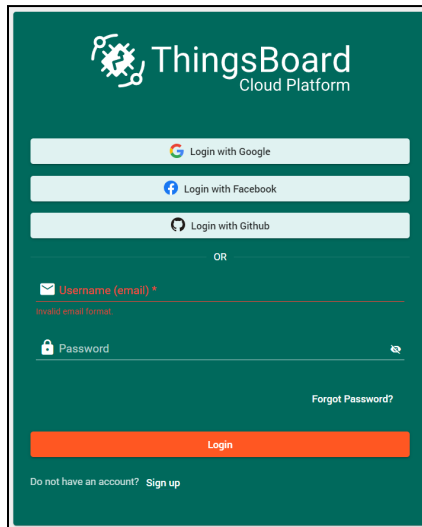
### 3.1 Overview

1. After integrating LORIoT with the ThingsBoard, you can connect, communicate, process and visualize data from devices in the ThingsBoard IoT platform. For Integration LORIoT need use **Professional Edition**, his edition is paid, it costs from \$10/month, but upon registration a trial (free) period of 30 days is given. For more information visit the website [LORIoT Integration](#).

### 3.2 Registration

1. Go to [ThingsBoard.cloud](#) suit and register in the cloud

**Figure 26. ThingsBoard Registration**

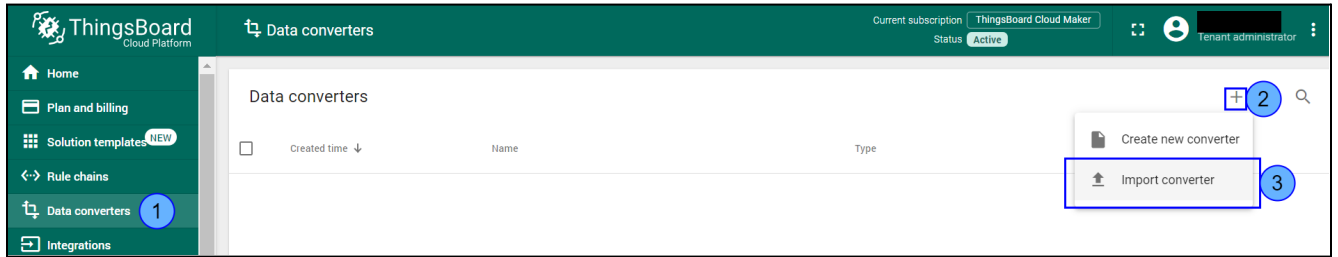


### 3.3 Import a Data Converter

1. After registering and entering the clouds Download DataConverter: [SensiLoRa2\\_0\\_DataConverterV0.1.json](#).

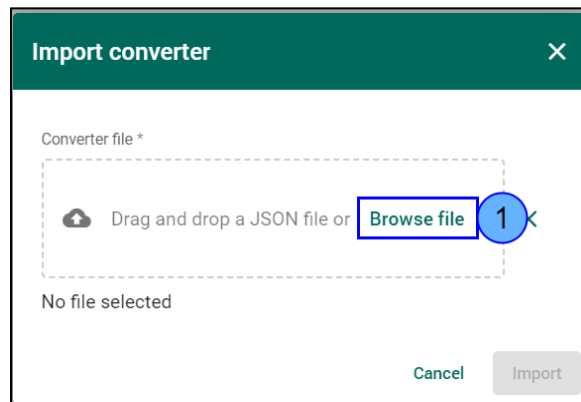
2. Add a Data Converter in ThingsBoard for this, go to **Data converters** (step 1), click **+** (step 2), and choose **Import converter** (step 3).

**Figure 27. Import a Data Converter**



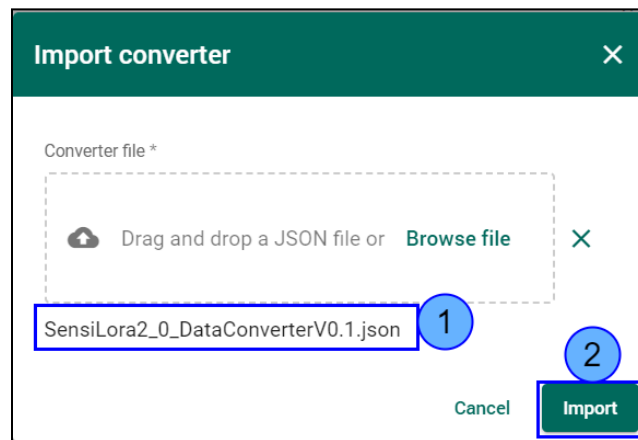
2. In the window, Import Convert drag the downloaded Data Converter or click on the **Browse file**(step 1) and select the **SensiLora2\_0 DataConverterV0.1.json**.

**Figure 28. Choose a Data Converter**



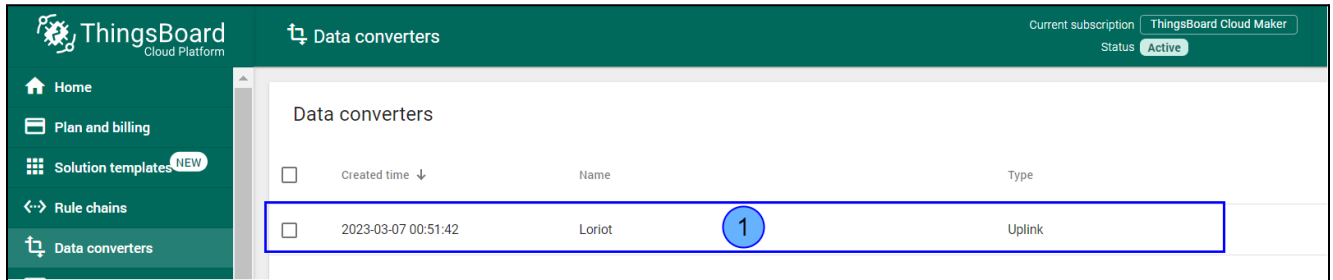
3. The selected Data converter will appear (step 1) and then click on **Import** (step 2).

**Figure 29. Click Import a Data Converter**



4. After Importing, a Data Converter with the name Loriot will appear in the window Data converters (step 1).

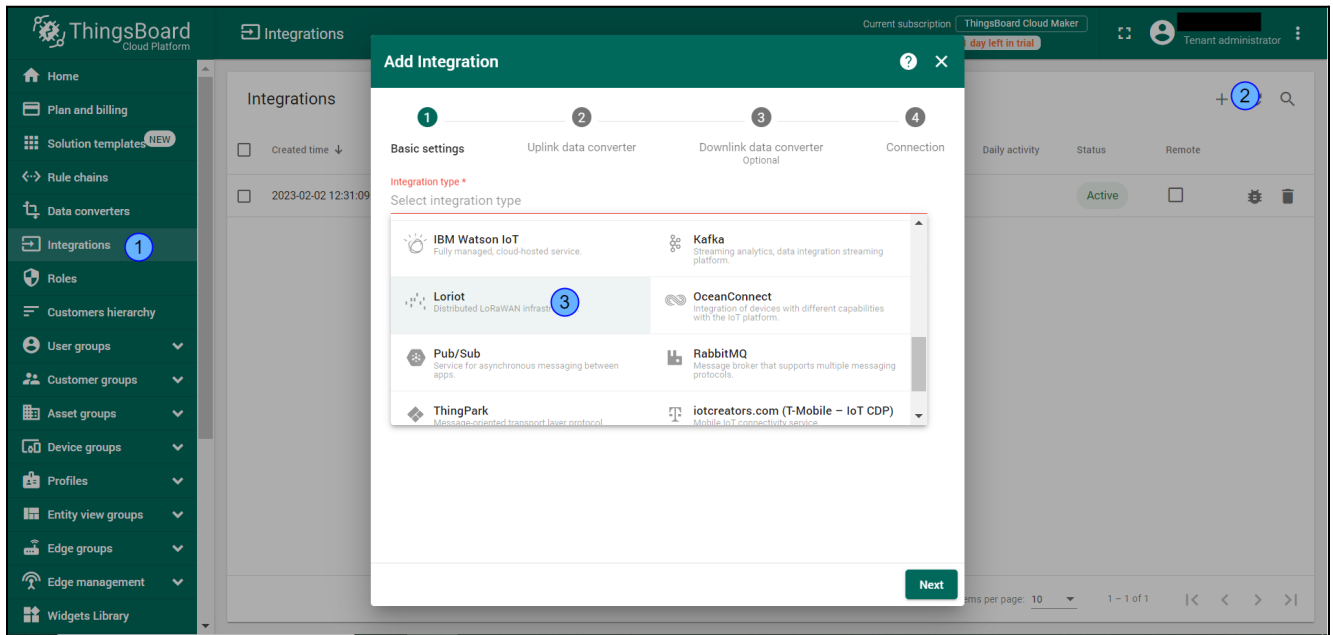
**Figure 30. Lorient Data Converter**



### 3.4. Create Integration

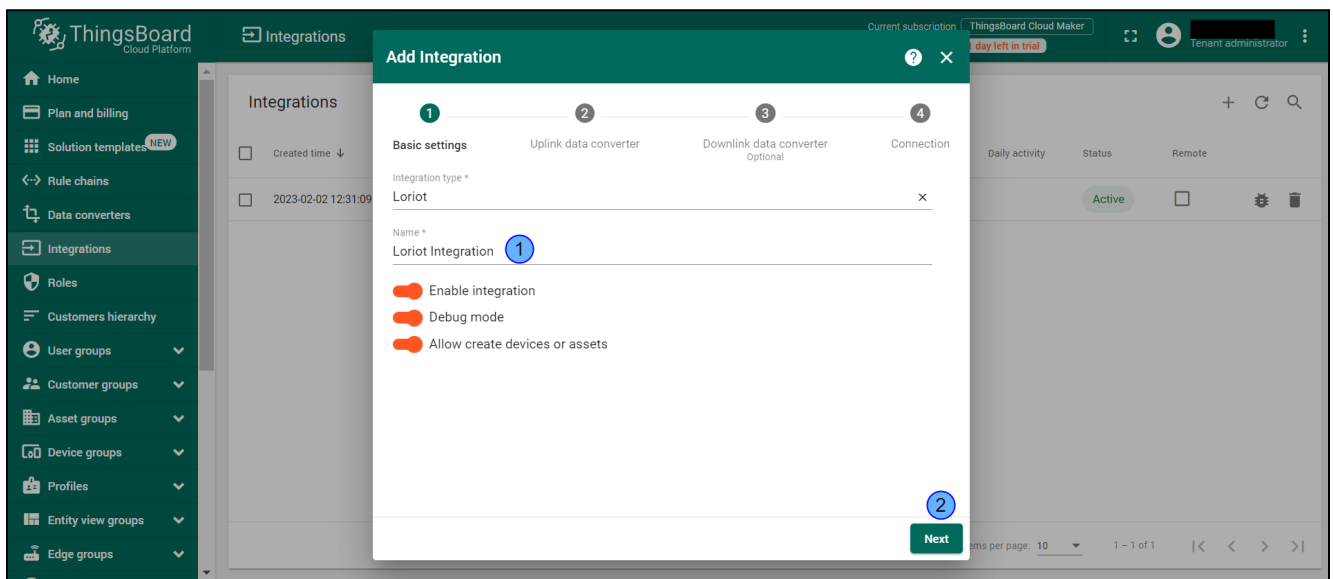
1. After importing Data Converter move on to the creation of Integration. Go to **Integrations** (step 1), click on **+** (step 2), and in Integration type choose **Lorient** (step 3).

**Figure 31. Add Integration**



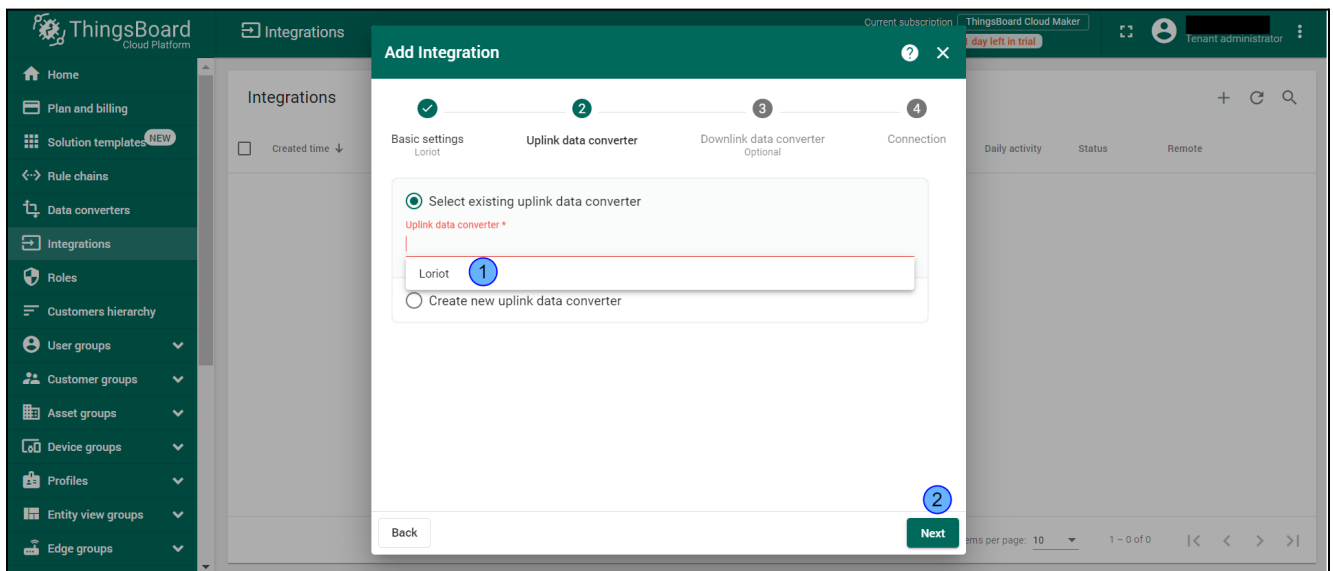
2. In line, **Name** enters the name **Lorient Integration** (step 1) and click **Next** (step 2).

**Figure 32. Basic settings Integration**



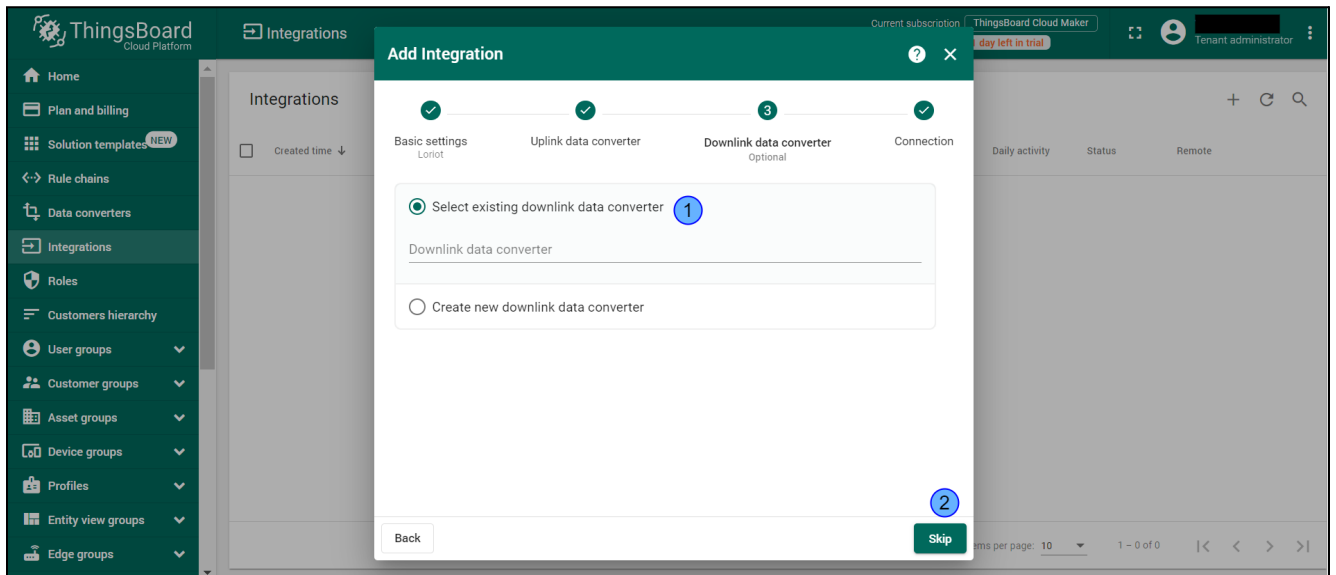
3. In Uplink Data Converter choose **Loriot** (step 1) and click **Next** (step 2).

**Figure 33. Choose Loriot**



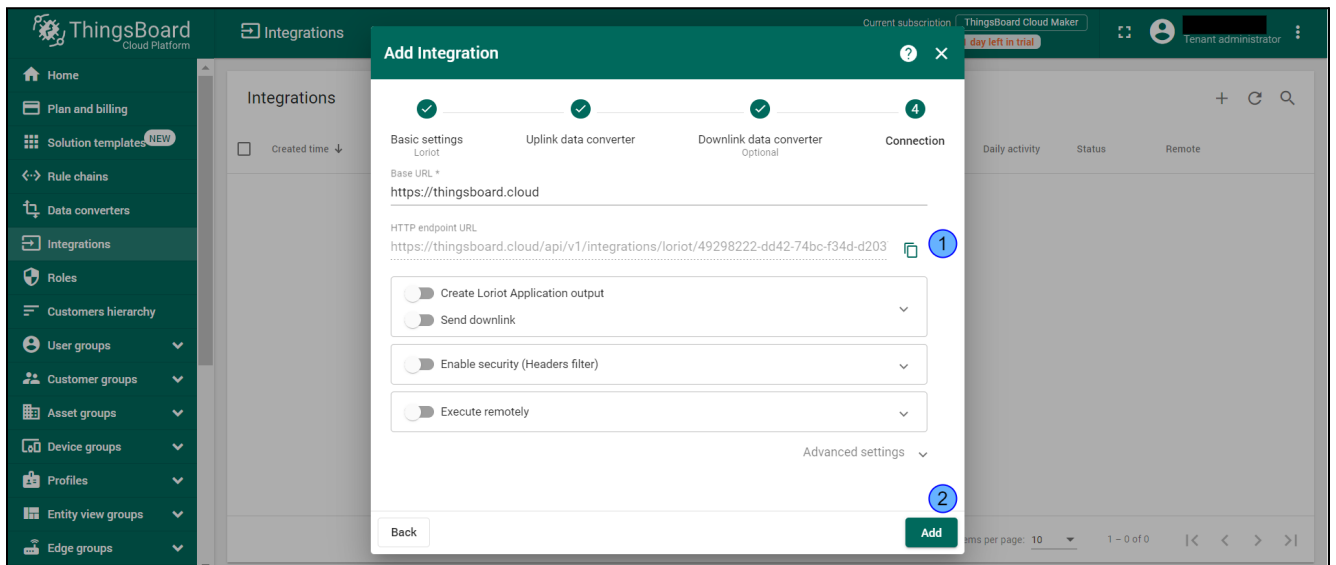
4. Choose **Select existing downlink data converter** and click to **Skip**.

**Figure 34. Select the existing downlink data converter**



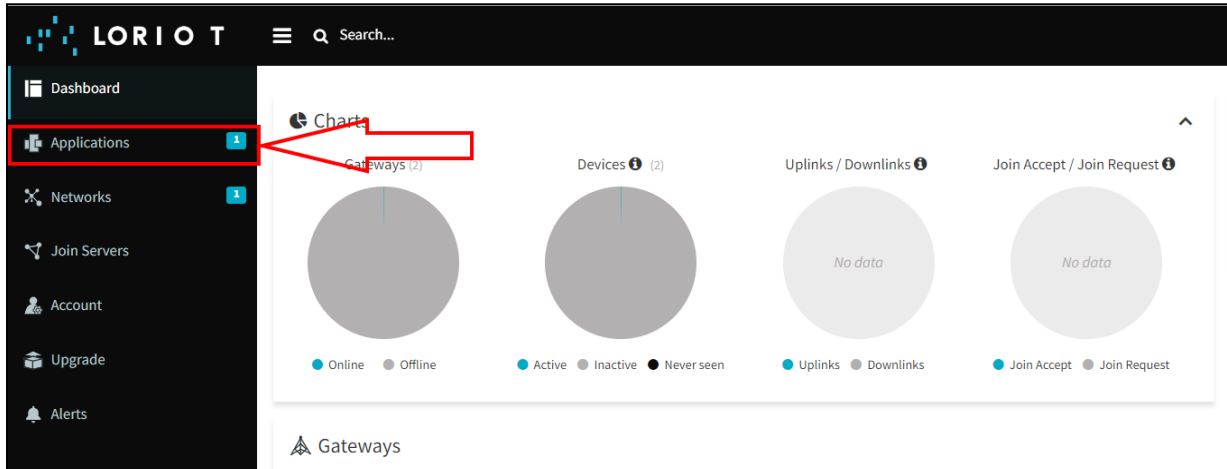
5. Click to **Copy HTTP endpoint URL** and click **Add**.

**Figure 35. Copy HTTP**



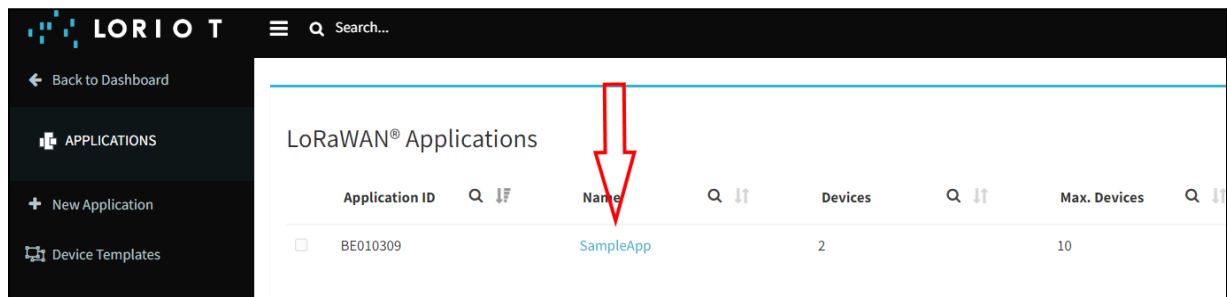
6. Go to **Applications** in LORIoT.

**Figure 36. Go to Applications**



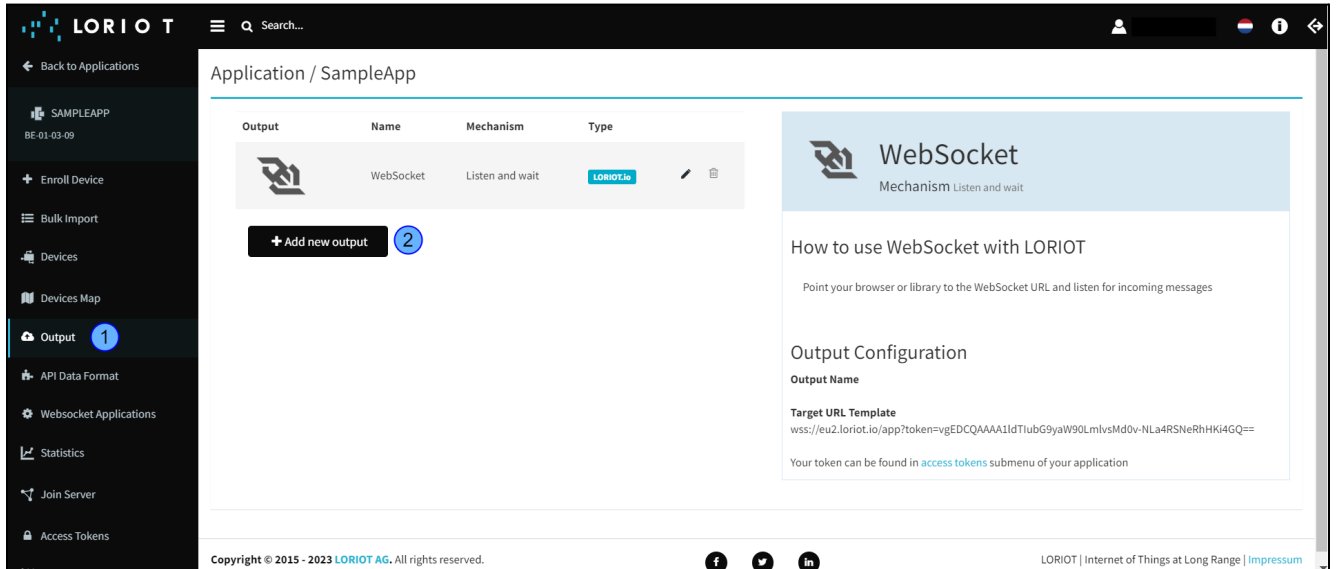
7. Select Application.

**Figure 37. Select Application**



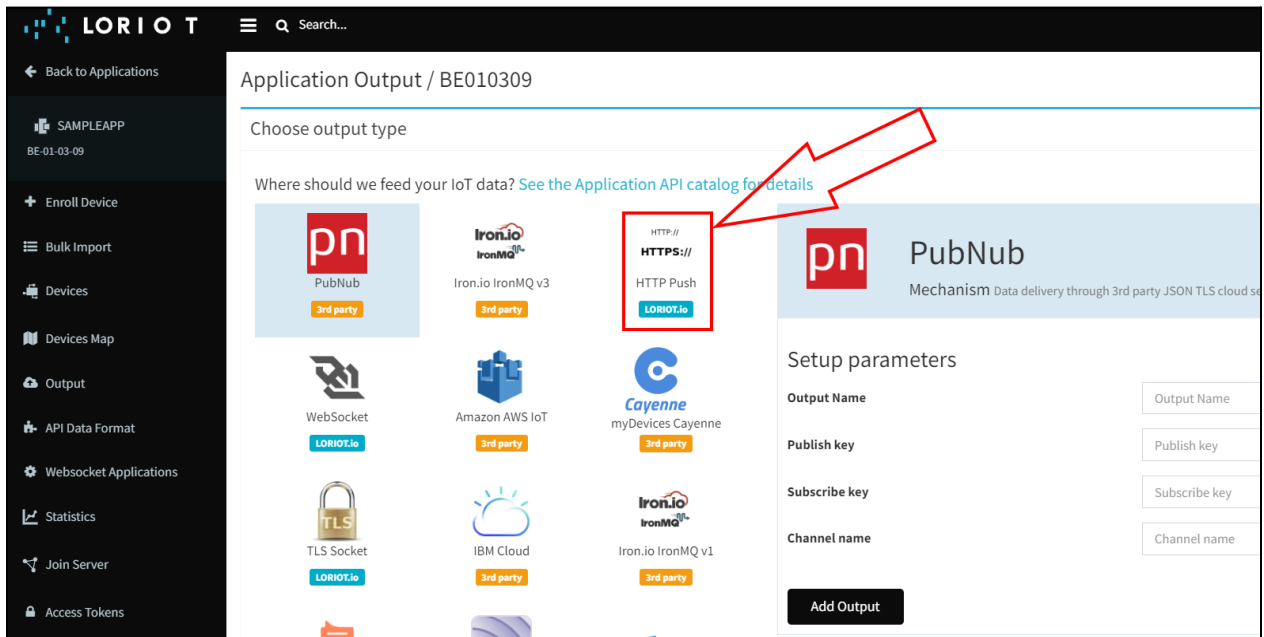
8. In Application go to **Output** (step 1) and click to **Add new output** (step 2).

Figure 38. Add Output



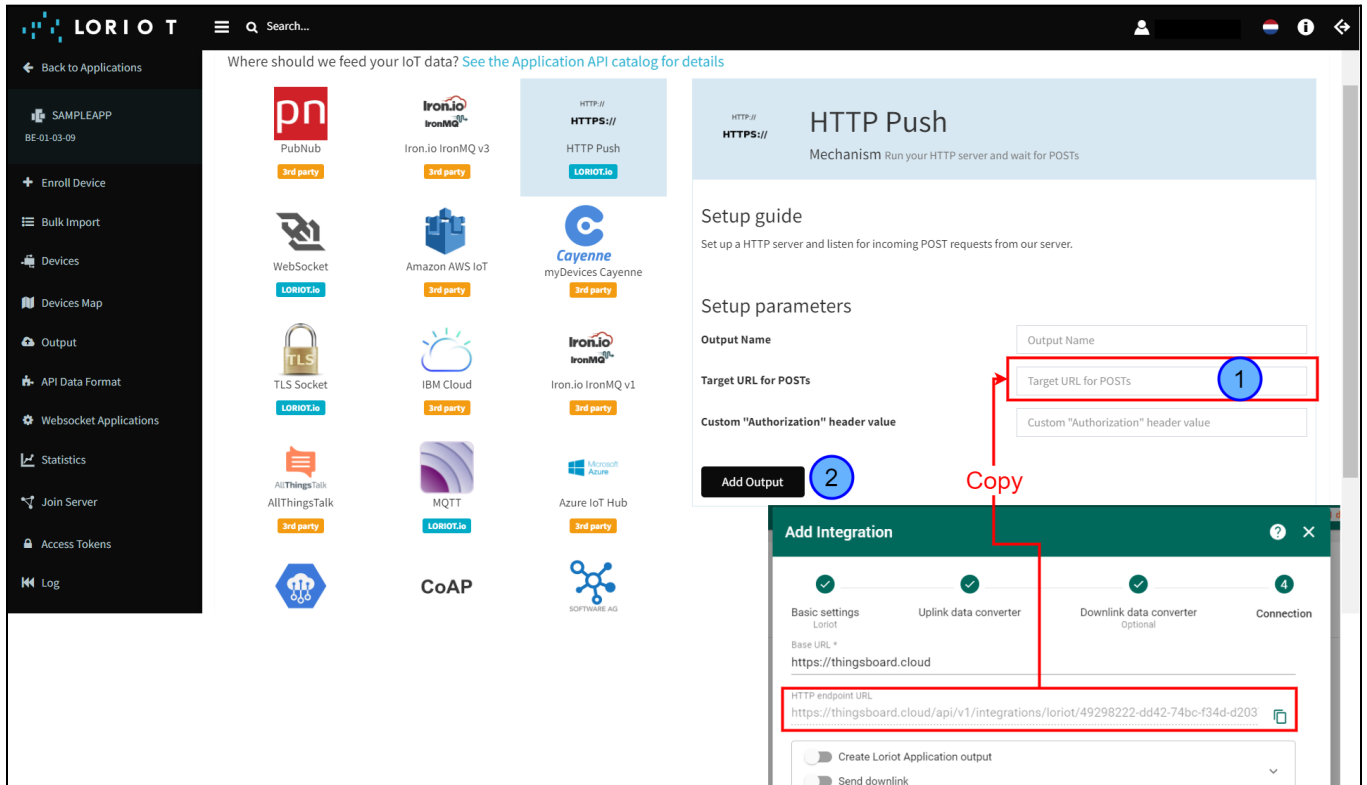
9. Select **HTTP PUSH** type.

Figure 39. Select HTTP Push



10. In **Target URL for POSTs** paste the HTTP URL with ThingsBoard (step 1) and click **Add Output** (step 2).

**Figure 40. Paste HTTP**

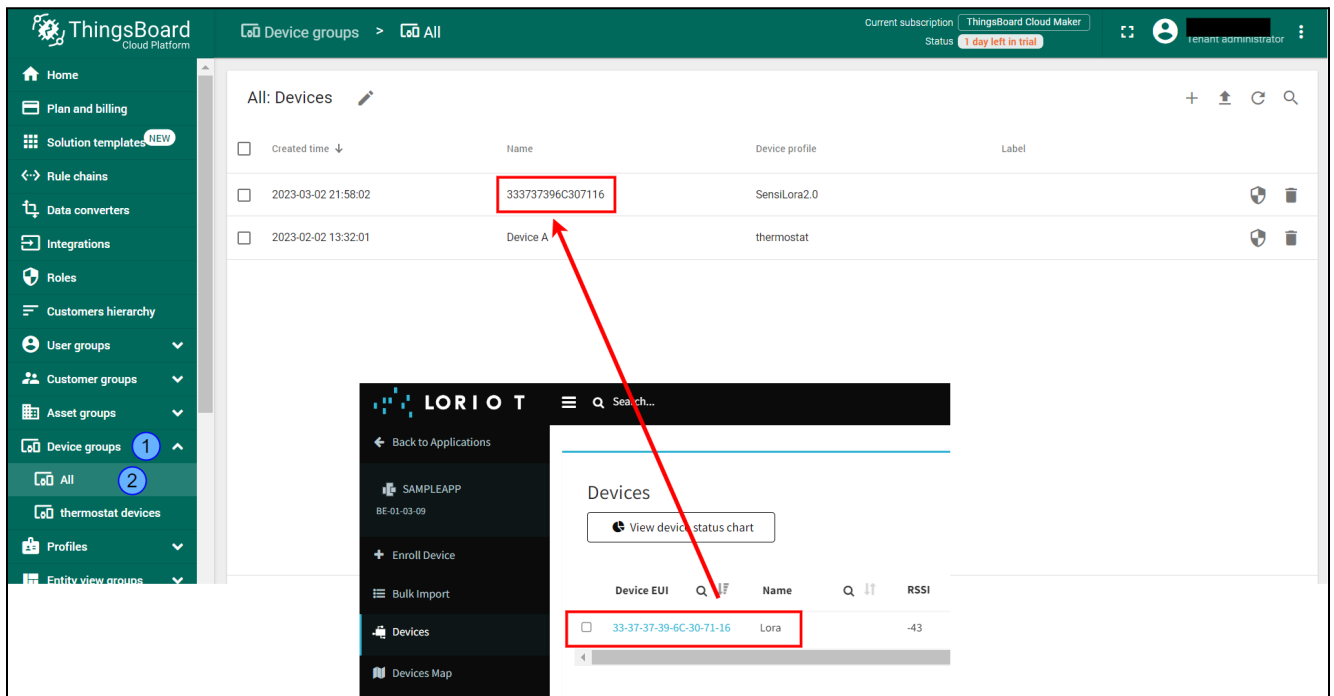


### 3.5 Device

1. To view, the active SensiLora 2.0 device go to **Device groups** (step 1), **All** (step 2), and in the window, **All: Devices** will contain a device that is connected to the Loriot server and transmits data to it.

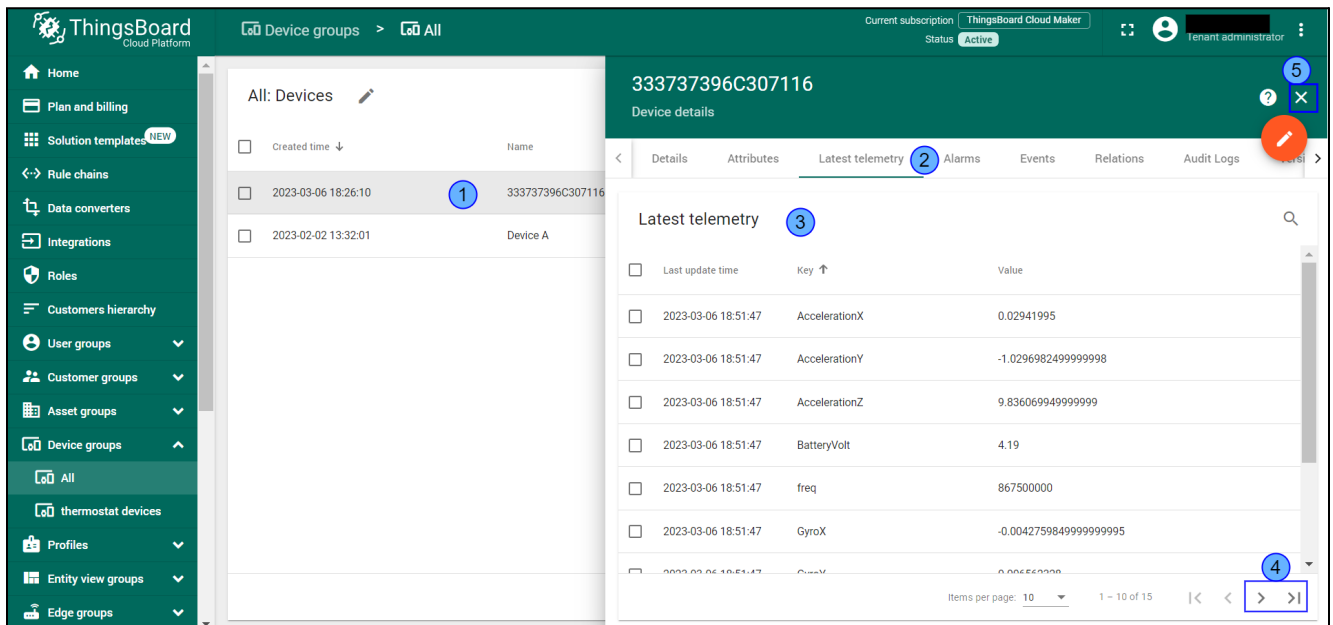


**Figure 41. Active Devices**



2. To view the received data from the sensors click on Device **SensiLora2.0** (step 1), next choose the **Latest telemetry** (step 2) and here you can see the readings of the sensors that the device measured (step 3), to view the rest of the readings you need to click on the **>** (step 4). To close the Device details click on the **X** (step 5).

Figure 42. Latest telemetry



## 3.6 Dashboard

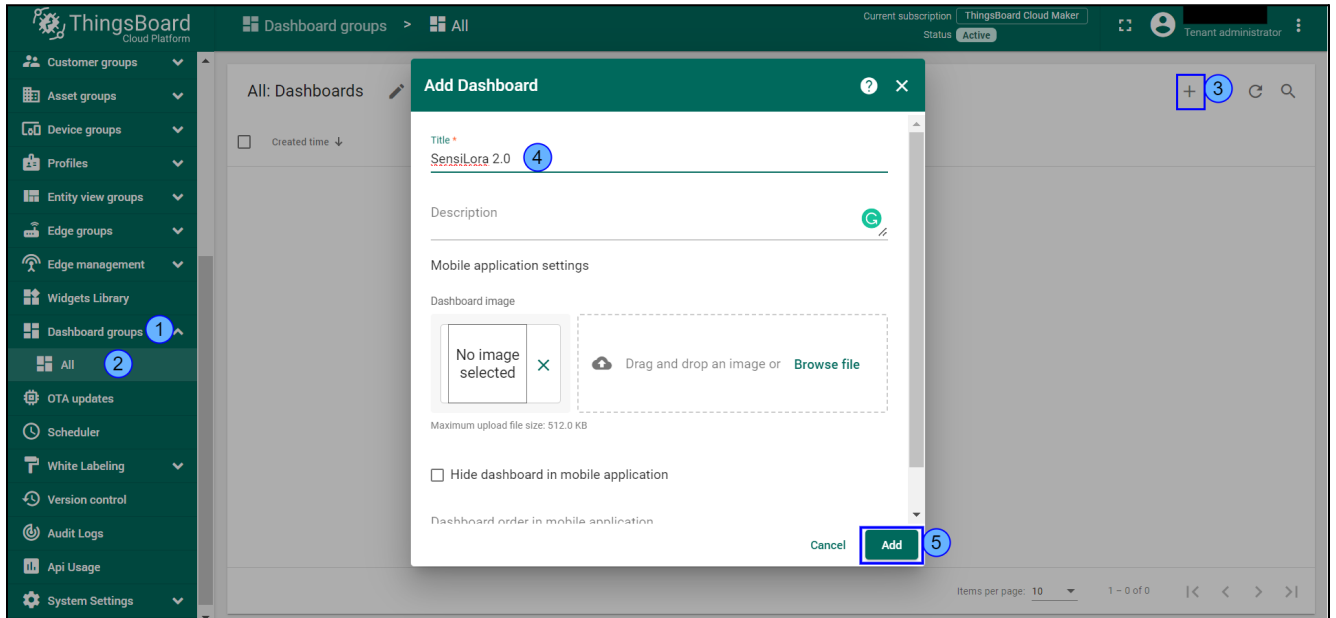
### 3.6.1 Overview

1. You can import a Dashboard and skip the next steps, for this go to section [3.6.5 Import Dashboard](#).

### 3.6.2 Add Dashboard

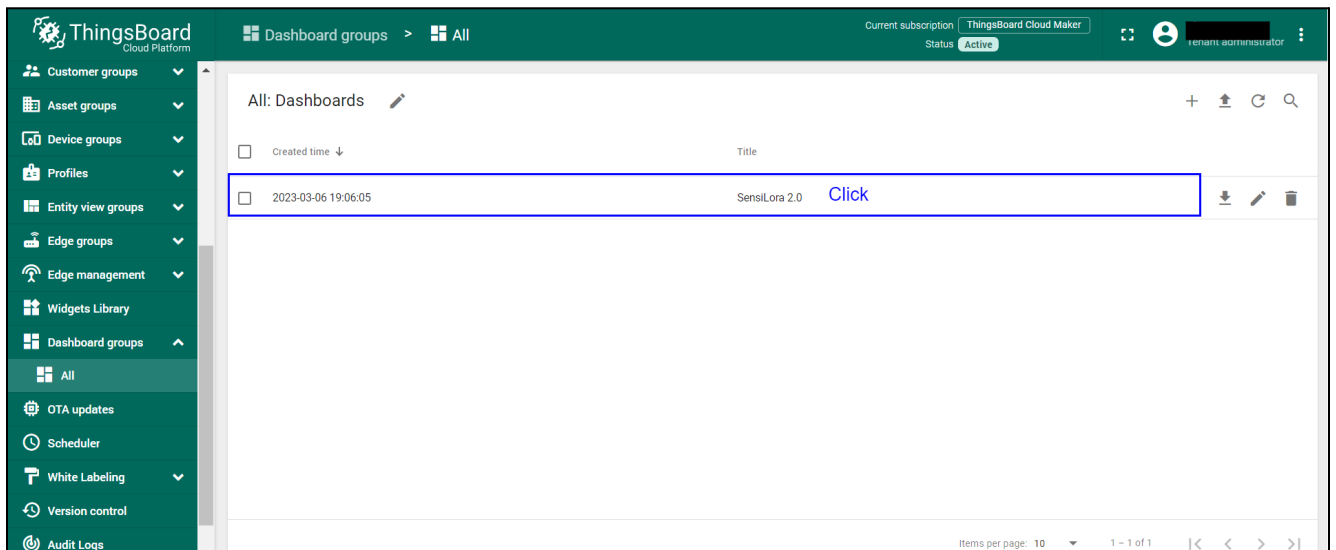
1. Add Dashboard, go to **Dashboard groups** (step 1), **All** (step 2), and click **+** (step 3). Enter a **SensiLora 2.0** in the **Title** field (step 4) and click **Add** (step 5).

**Figure 43. Add Dashboard**



2. Click on SensiLoRa 2.0 Dashboard.

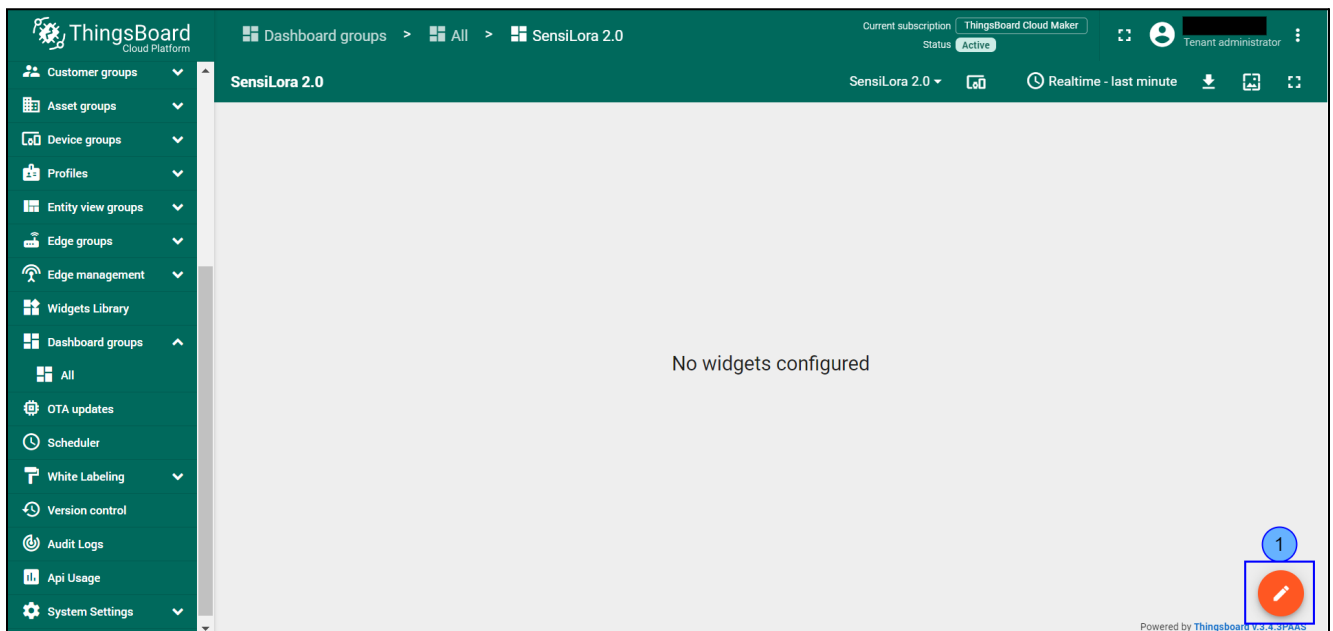
**Figure 44. Go to SensiLoRa 2.0 Dashboard**



### 3.6.3 Add Entity aliases

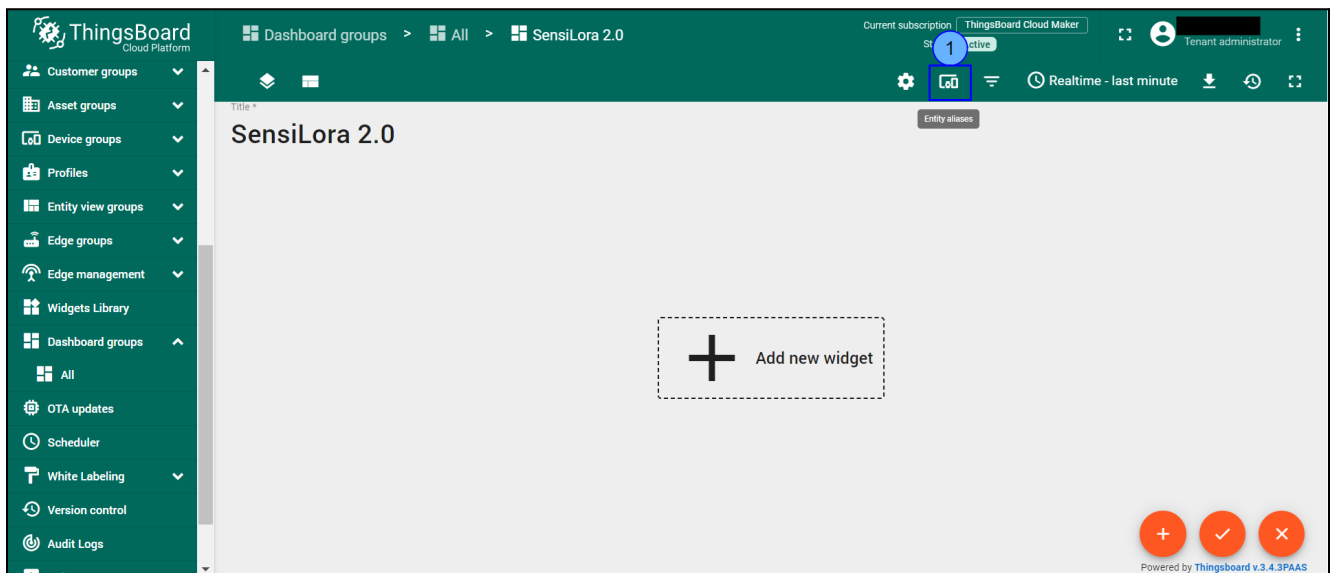
1. Click on **Change** Dashboard (step 1).

**Figure 45. Change Dashboard**



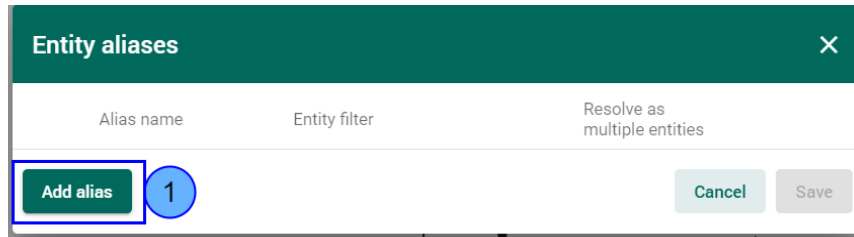
2. Click on **Entity aliases** (step 1).

**Figure 46. Entity aliases**



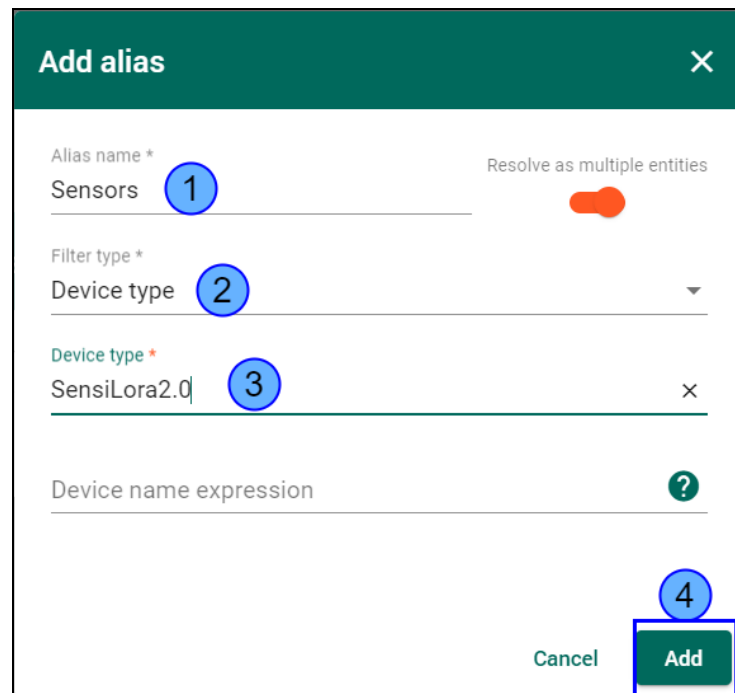
3. Click on **Add alias** (step 1).

Figure 47. Go to Add alias



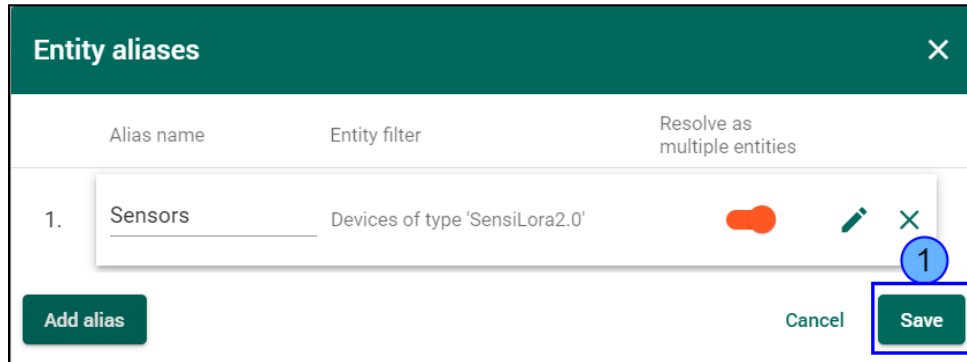
4. In Add alias enters the name: **Sensors** (step 1), and next choose **Device type** (step 2), in Device type, enter the **SensiLora 2.0** type (step 3), and click **Add** (step 4).

Figure 48. Filling Add alias



5. Click to **Save** (step 1).

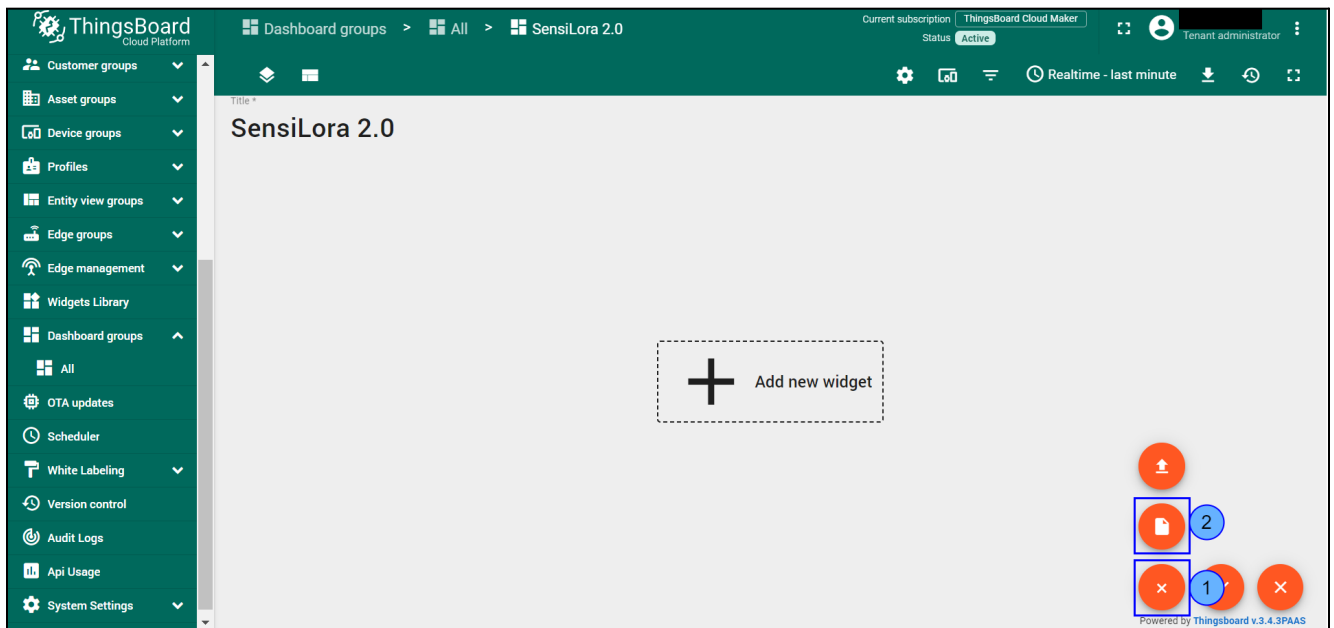
**Figure 49. Save alias**



### 3.6.4 Add Temperature widget

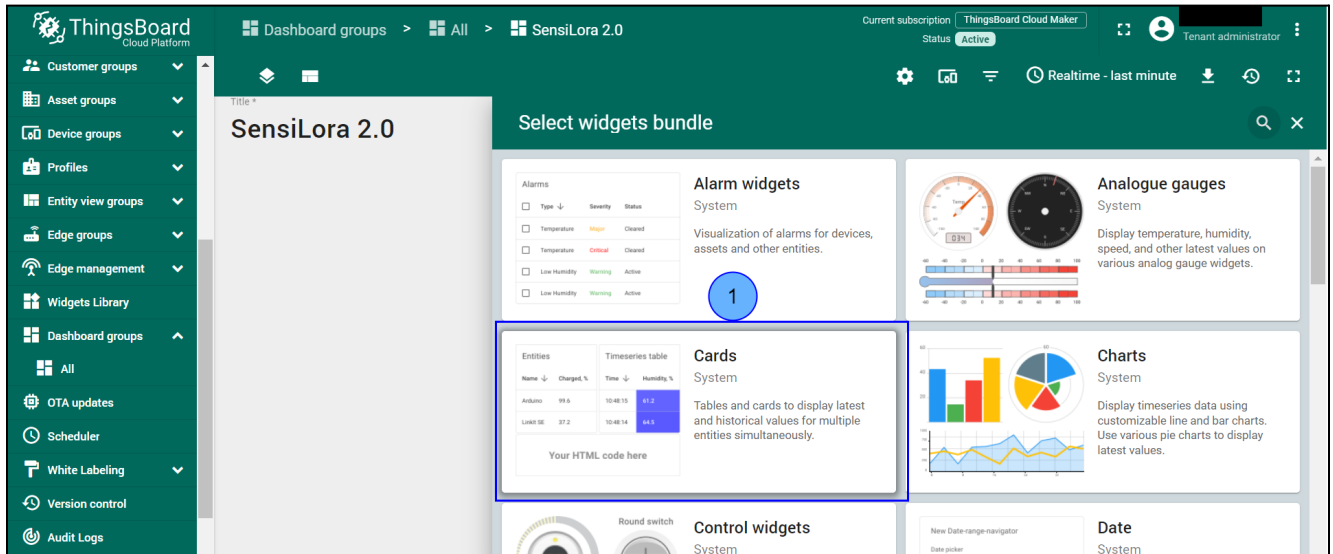
1. Add a new widget. For this click **Add new widget** (step 1) and choose to **Create new widget** ( step 2).

**Figure 50. Add widget**



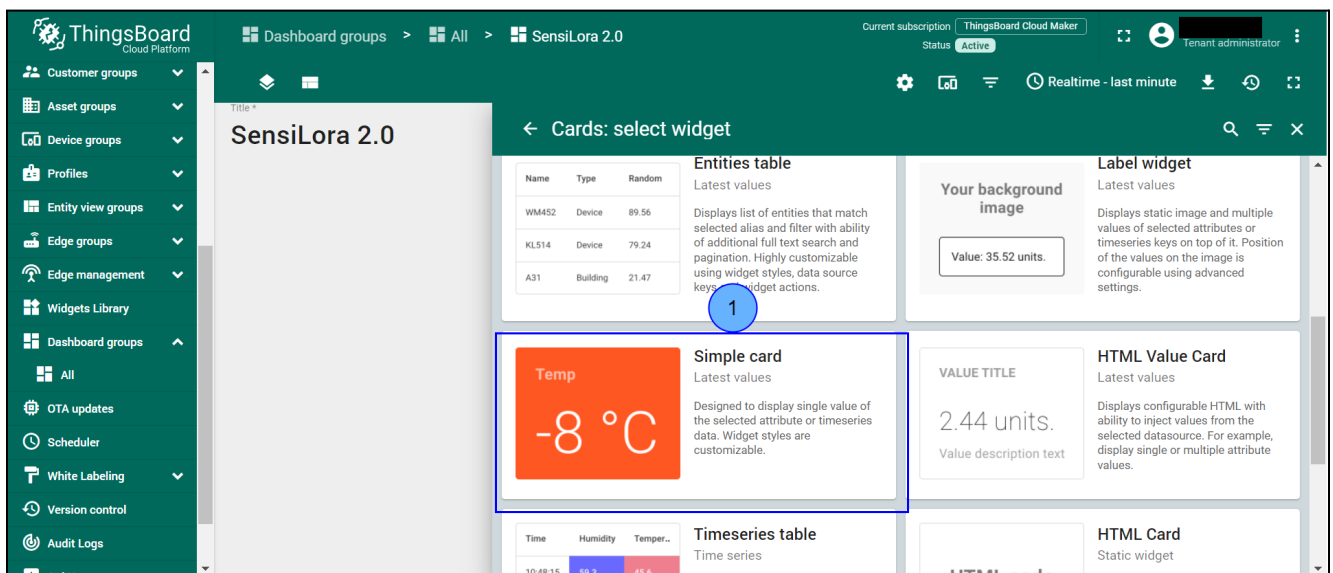
2. Choose the **Cards** widget bundle (step 1).

**Figure 51. Choose the Cards widget**



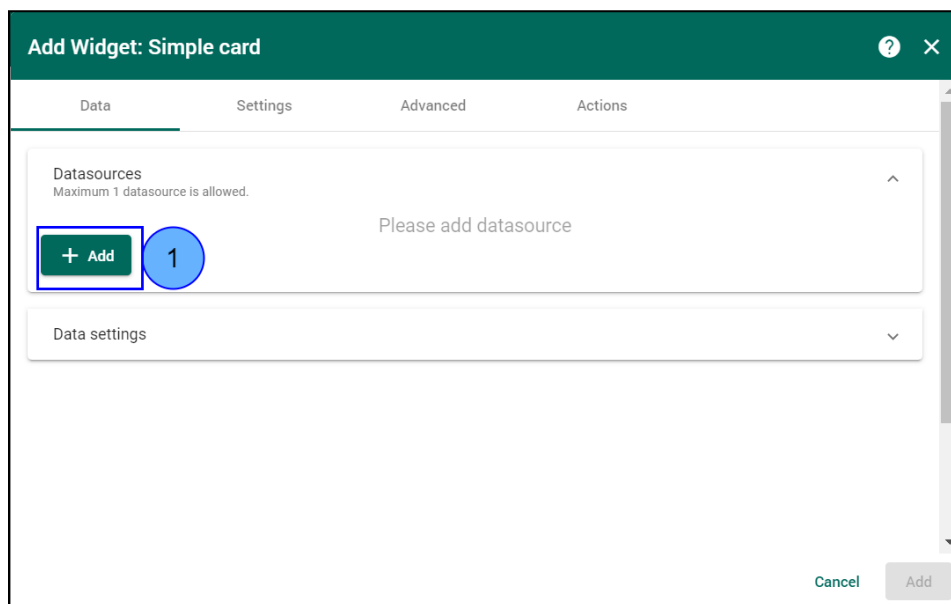
3. Choose the **Simple card** widget (step 1).

**Figure 52. Choose the Simple card**



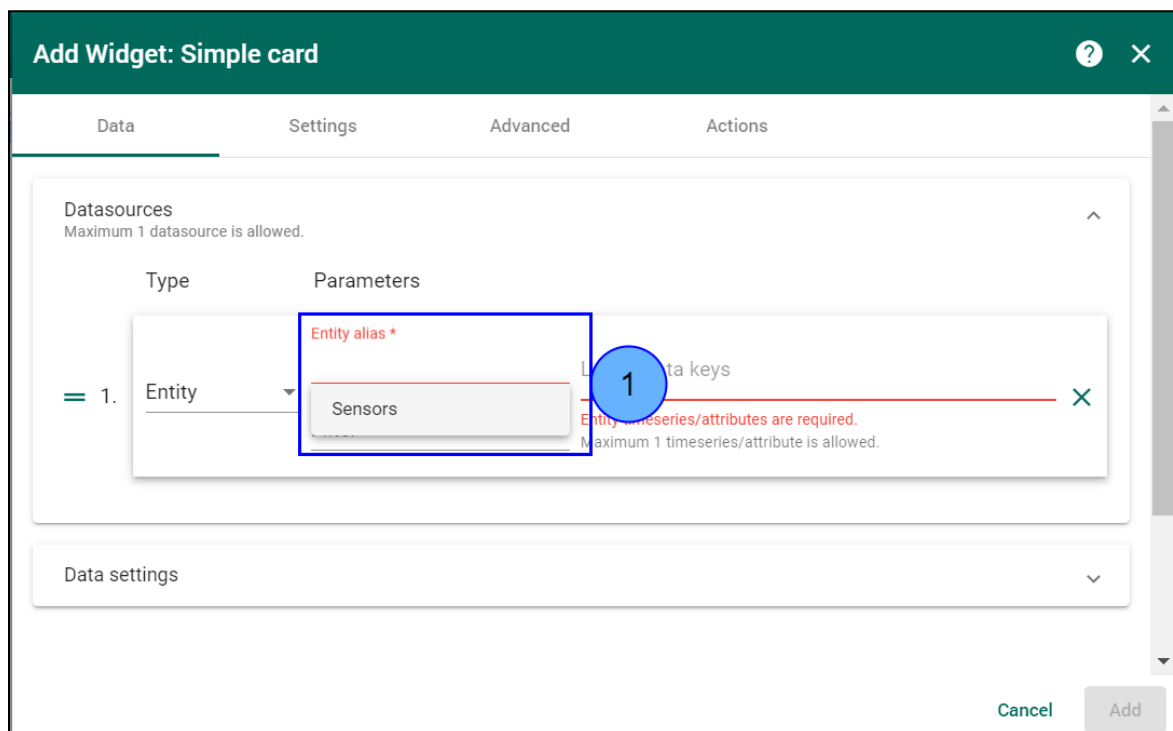
4. Click to **Add** datasource (step 1).

**Figure 53. Add Datasource**



5. In **Entity alias** choose **Sensors** (Step 1).

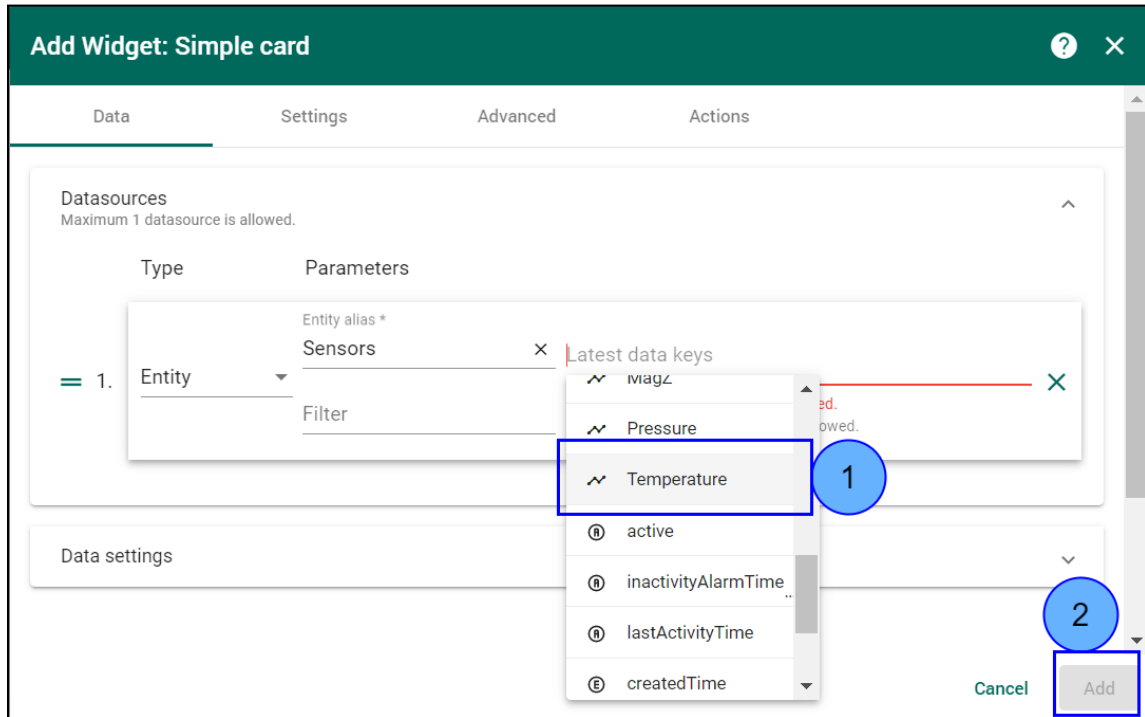
**Figure 54. Entity alias**



6. Choose the **Temperature** key (step 1) and click **Add** (step 2).

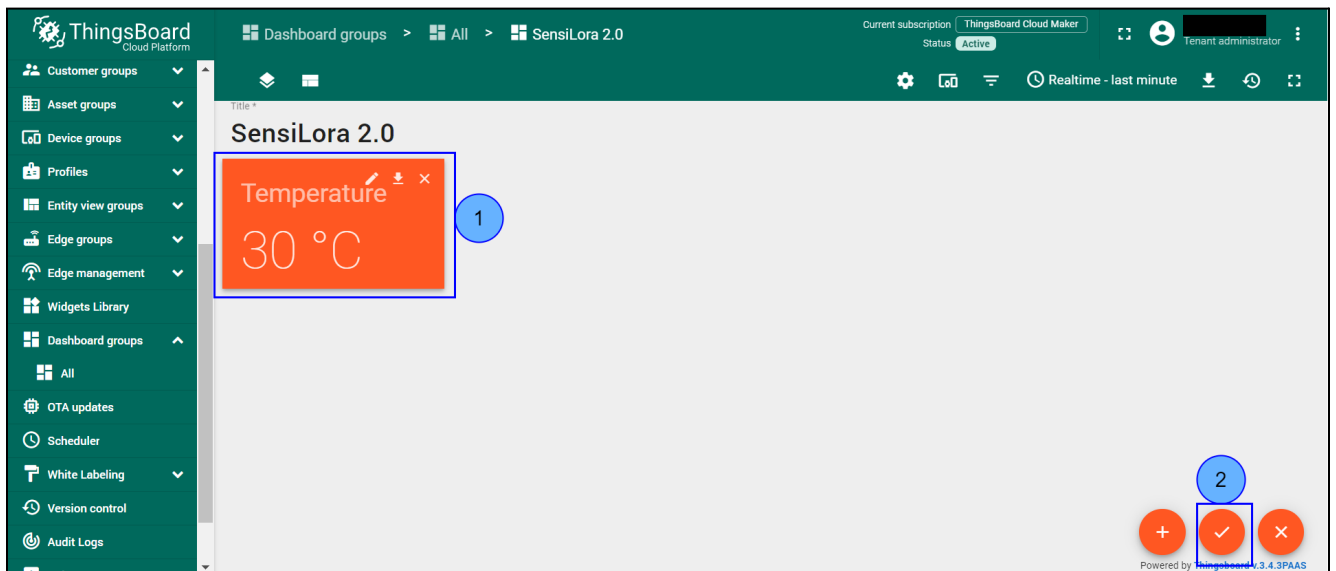


**Figure 55. Add a Simple card**



7. The added widget can be seen on the Dashboard (step 1) click to **Save** changes (step 2).

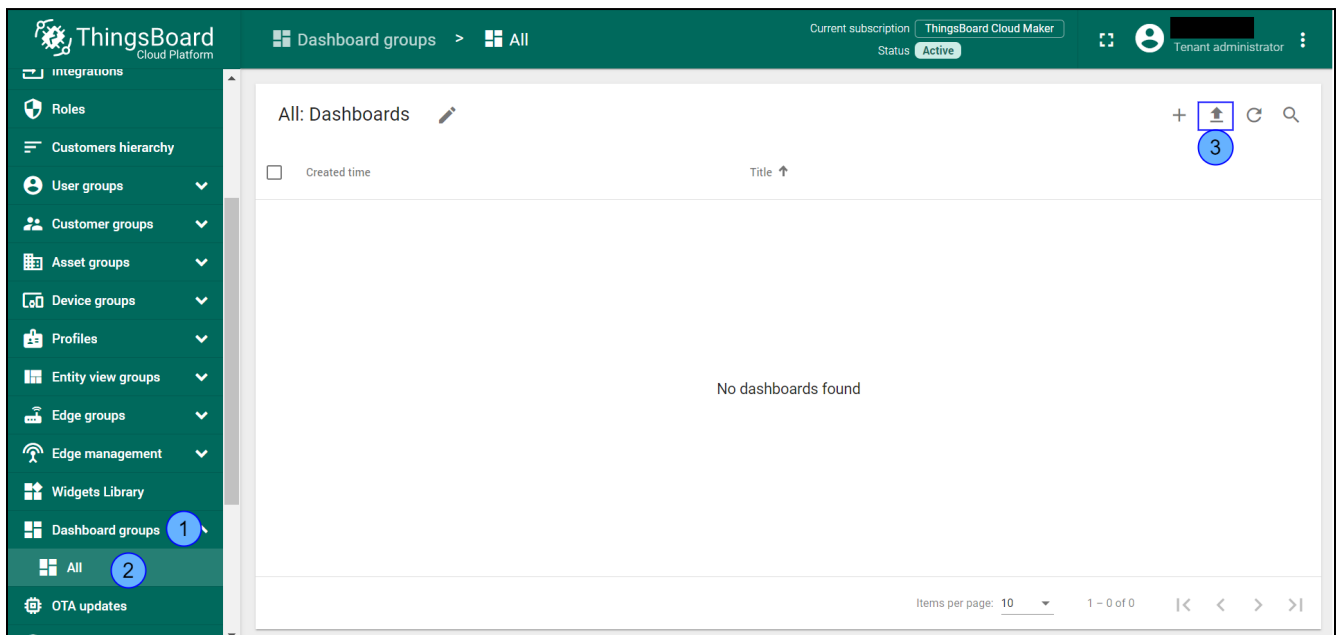
**Figure 56. Save Dashboard**



### 3.6.5 Import Dashboard

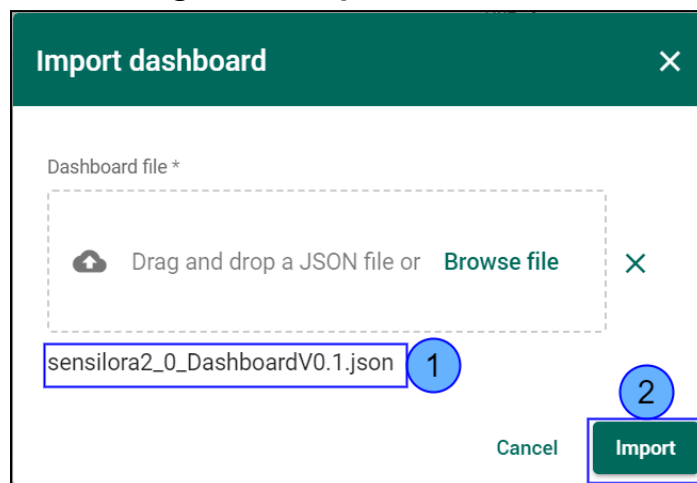
1. Download the Dashboard: [SensiLoRa2\\_0\\_DashboardV0.1.json](#)
2. Go to **Dashboard groups** (step 1), **All** (step 2), and click **Import dashboard** (step 3).

**Figure 57. Choose Import Dashboard**



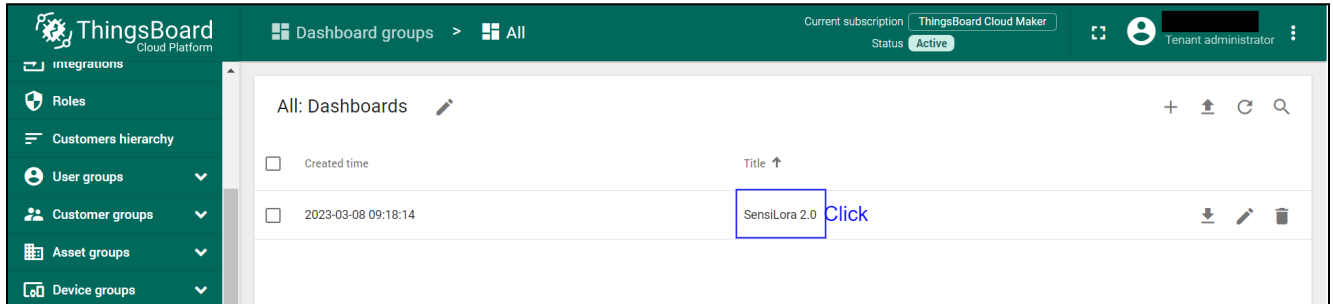
3. Drag and drop the download Dashboard. Import Dashboard should be displayed (step 1), after clicking Import (step 2).

**Figure 58. Import Dashboard**



4. Go to SensiLoRa 2.0 Dashboard.

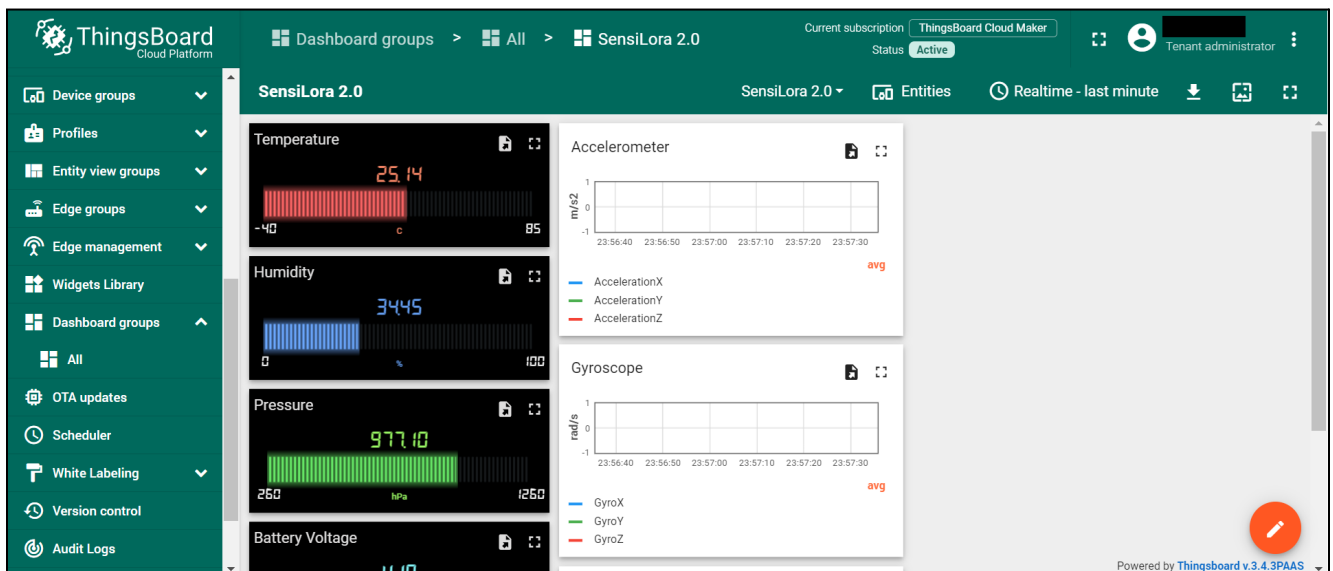
Figure 59. Go to Dashboard



5. In SensiLoRa 2.0 Dashboard the following widgets are located:

- **Temperature**, units: °C
- **Humidity**, units: %
- **Pressure**, units: hPa
- **Battery voltage**, units: V
- **Light**, units: lux
- **Accelerometer**, units: m/s<sup>2</sup>
- **Gyroscope**, units: rad/sec
- **Magnetometer**, units: μT

Figure 60. SensiLoRa 2.0 Dashboard

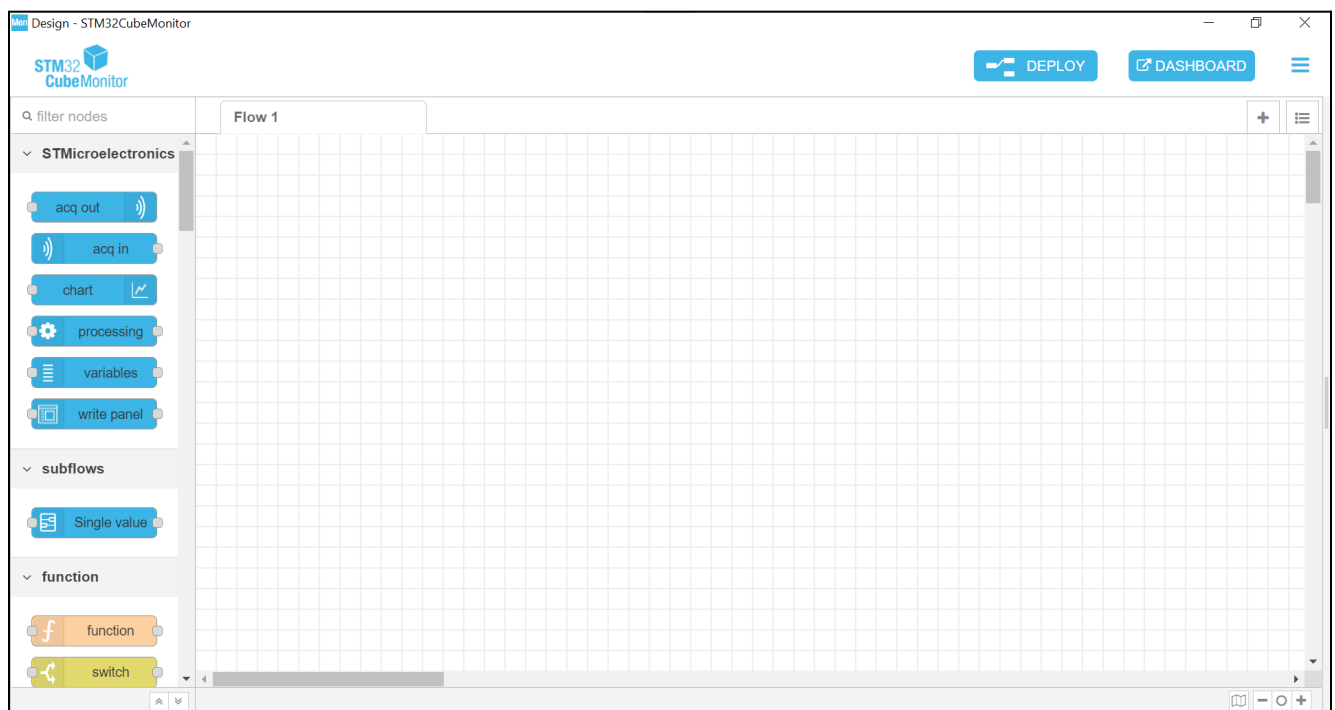


## 4 STM32CubeMonitor

### 4.1 Install STM32CubeMonitor

1. Download and install a program from the ST site at this link [STM32CubeMonitor](#) and download an example project by this link [SensiLoRaCubeMonitorV0.3.json](#). The main window STM32CubeMonitor is illustrated in Figure 61.

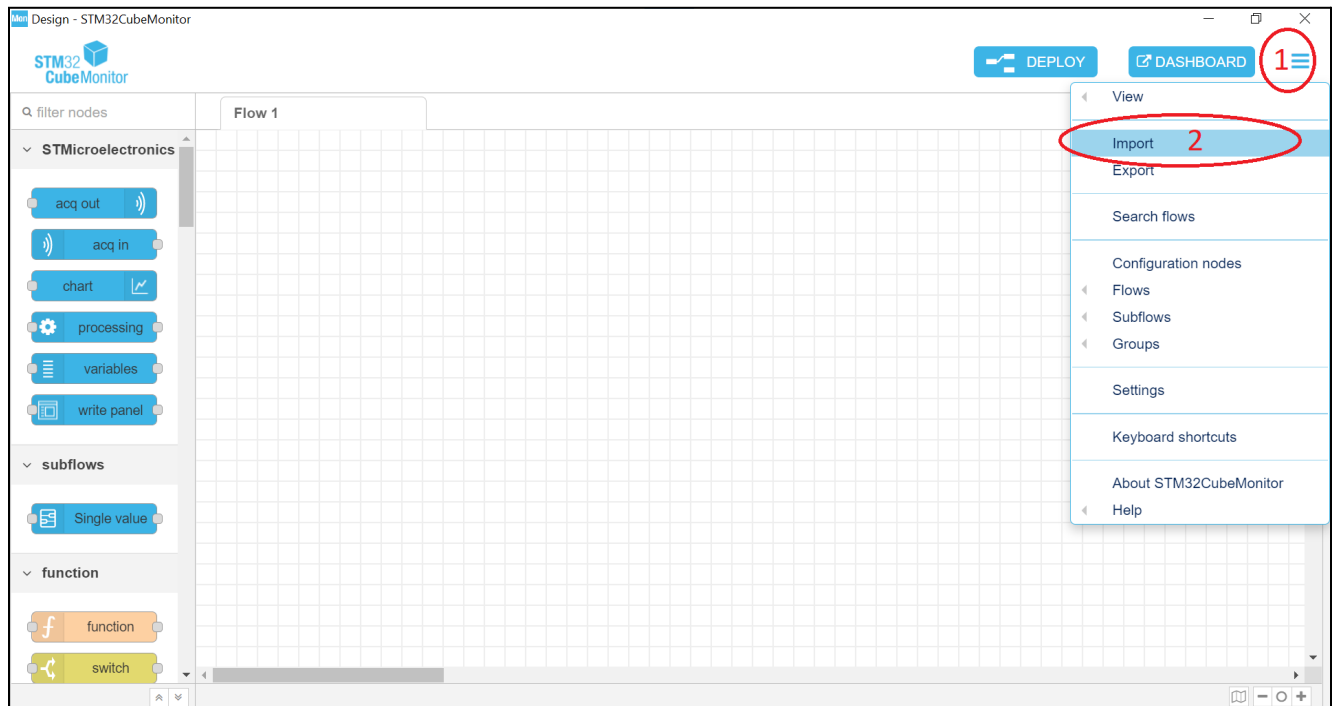
**Figure 61. Main window STM32CubeMonitor**



## 4.2 Import project

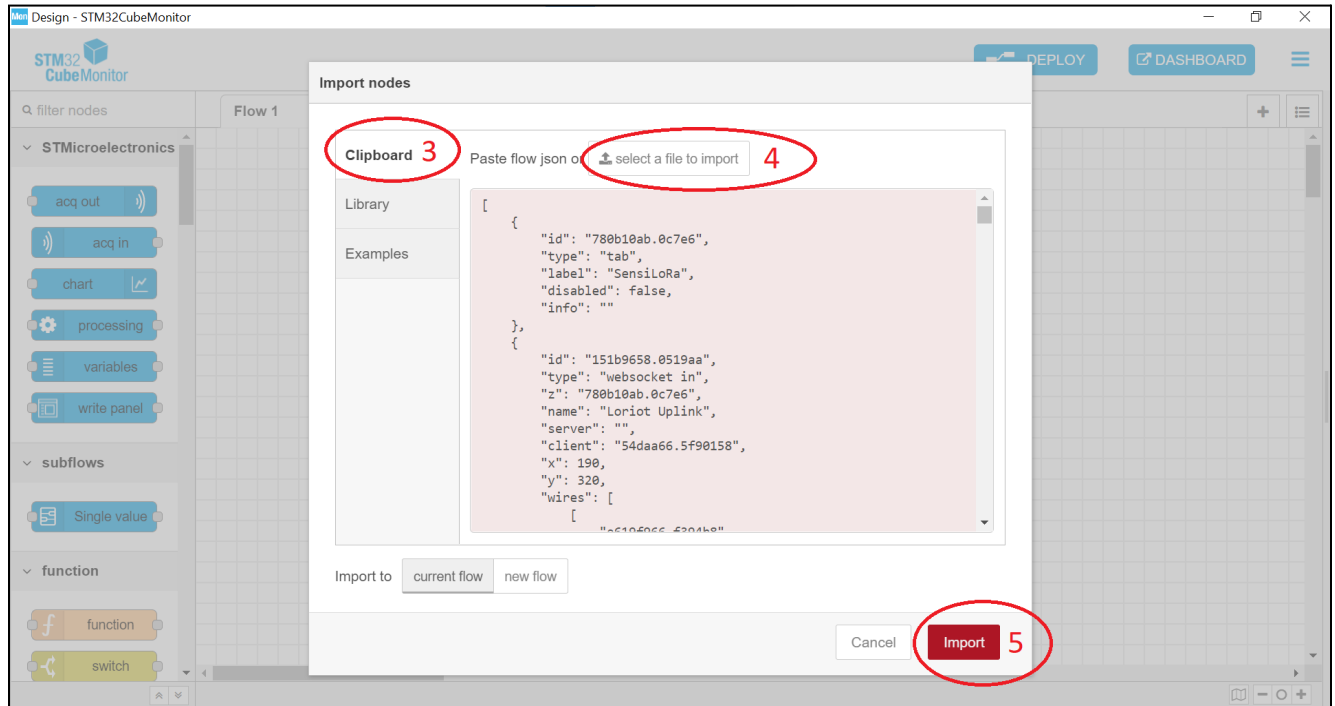
1. Opening the program and clicking on the **selection tab** (step 1), a selection menu will open, and then select **Import** (step 2). This action is illustrated in Figure 62.

**Figure 62. Selection Import menu**



2. A window will open with the choice of a file to import. In the import window, select **Clipboard** (step 3), then click on **select a file to import** (step 4) and select the file [SensiLoRaCubeMonitorV0.3.json](#) which we downloaded. After selecting the file click on **Import** (step 5). This action is illustrated in Figure 63.

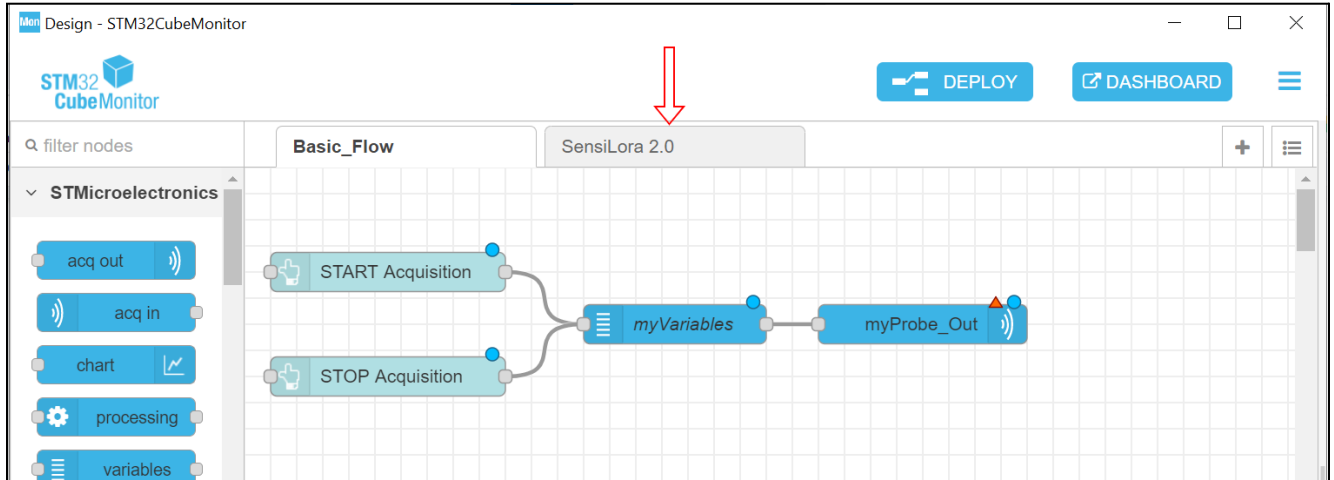
Figure 63. Import project



### 4.3 Configuration Lorient Uplink

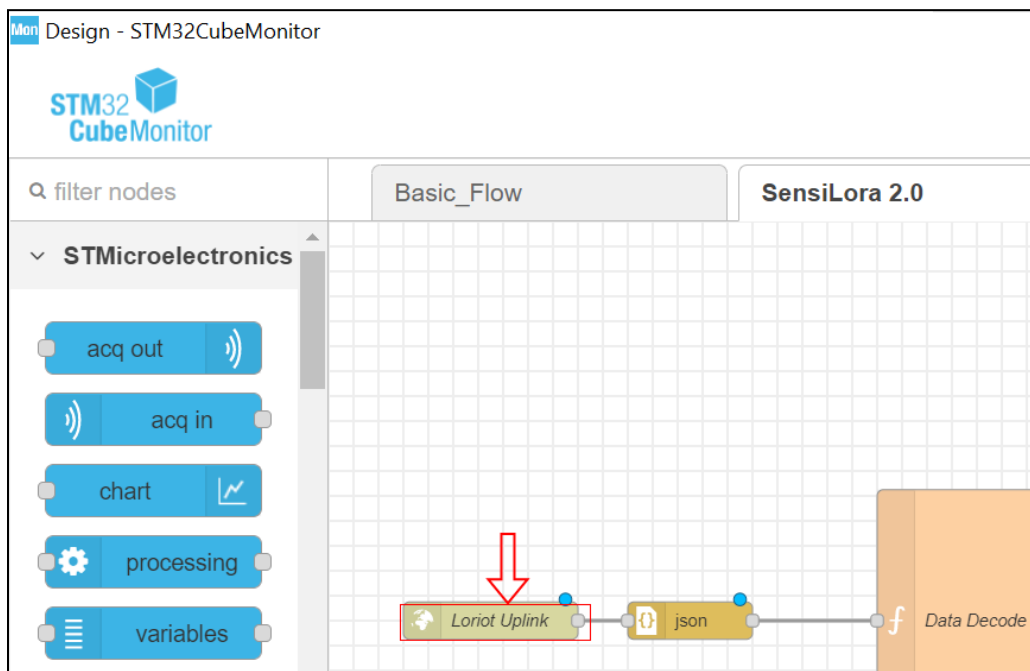
1. Go to the tab SensiLoRa 2.0 (Figure 64).

**Figure 64. Go to the SensiLoRa project**



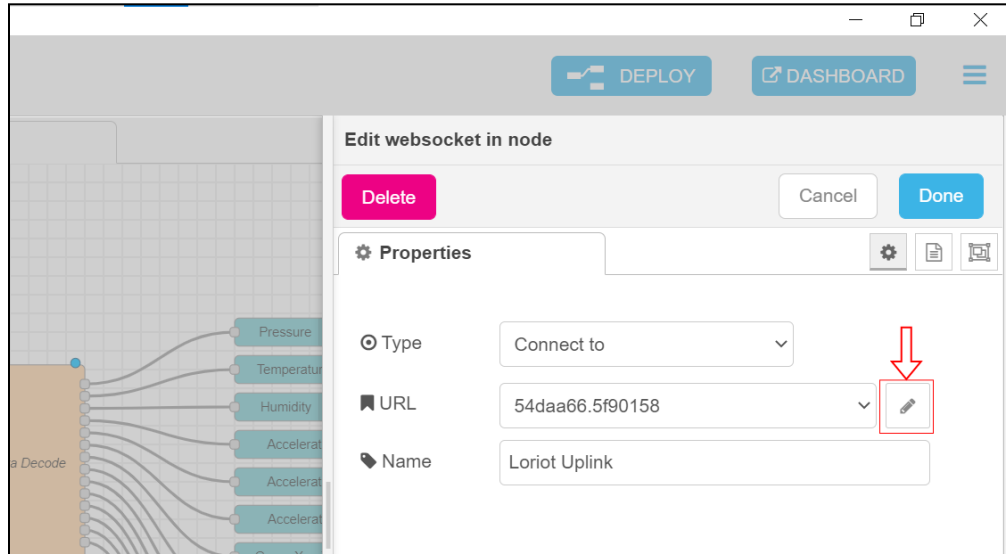
2. Configure the WebSocket **Lorient Uplink**, and double-click on it to open settings (Figure 65).

**Figure 65. Open Lorient Uplink**



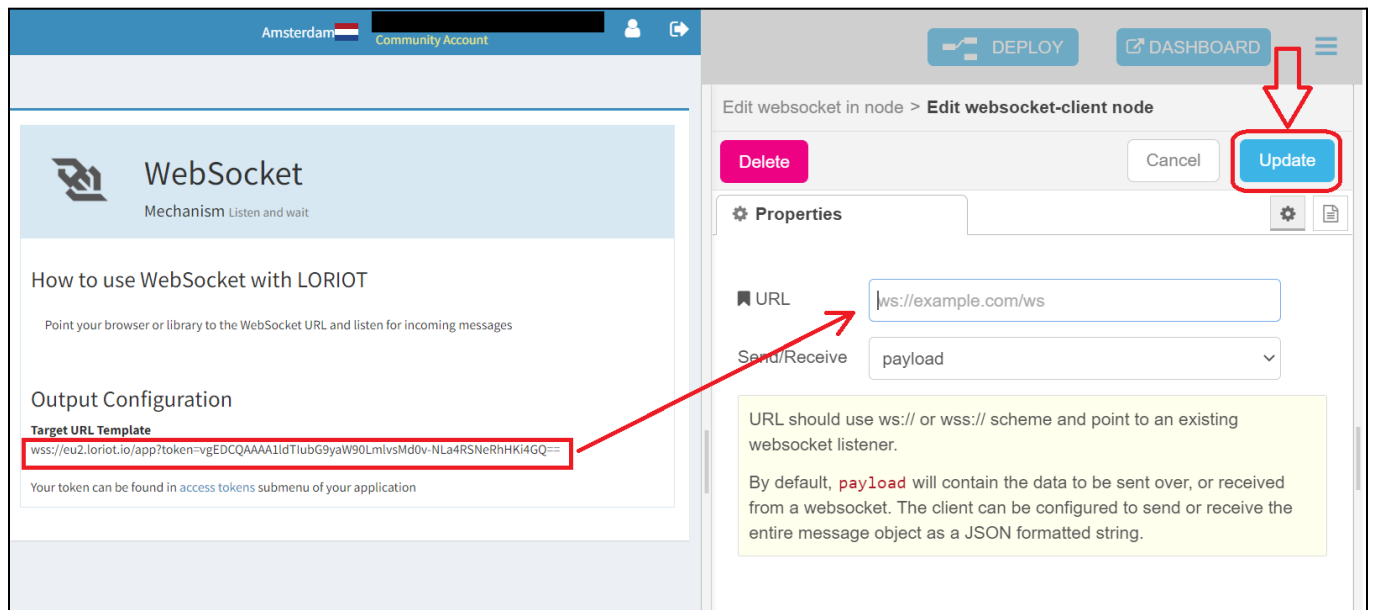
3. When opening the setting window, here we click on the **URL editing icon** ( Figure 66).

**Figure 66. Setting the Lorient Uplink**



4. In this window, we must insert the URL. If the Lorient server is used, then the link must be taken from [2.4 Lorient Uplink](#). After inserting the URL, click on **Update**. This action is illustrated in Figure 67.

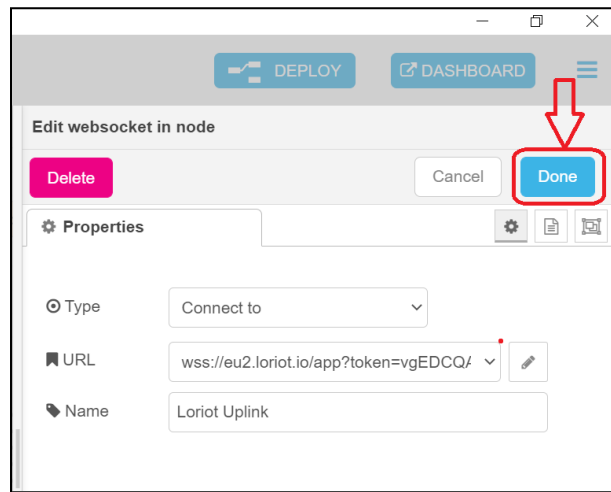
**Figure 67. URL**



5. Click on **Done** (Figure 68) to save the URL.

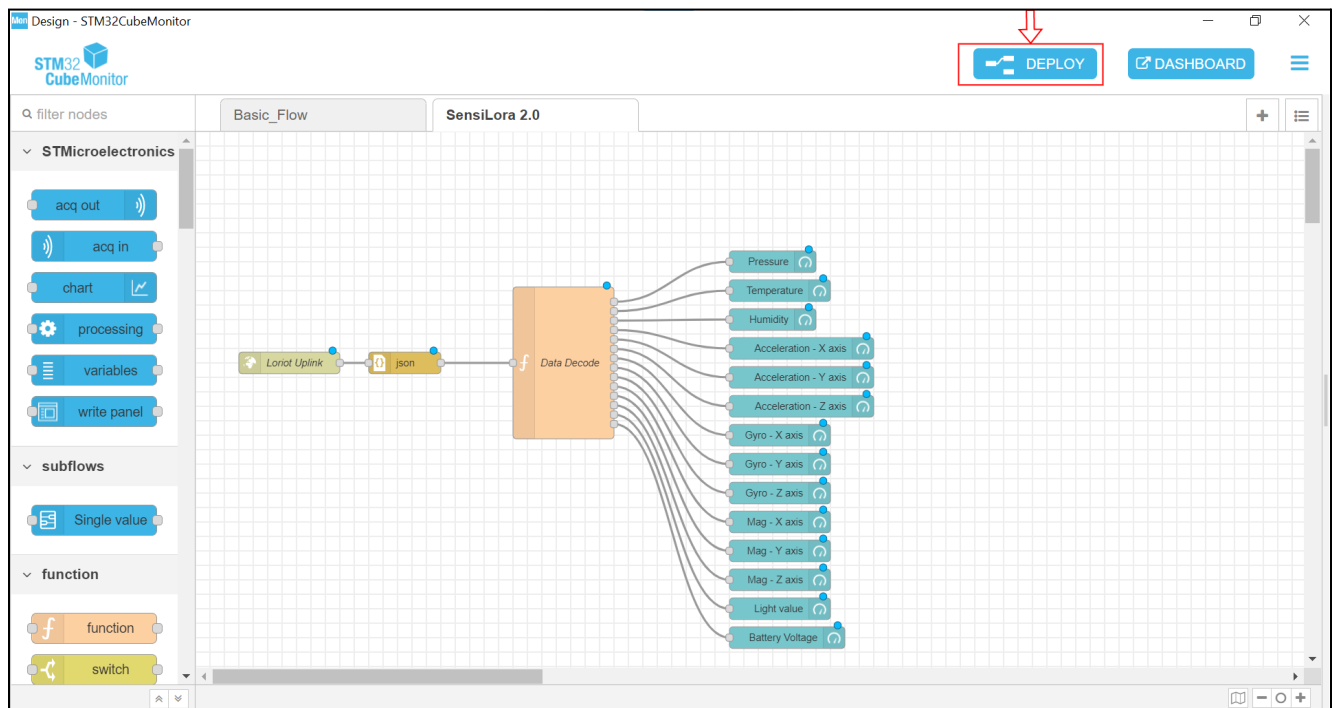


Figure 68. Save the URL



6. Click on **Deploy** (Figure 69) so that our changes are saved and take effect.

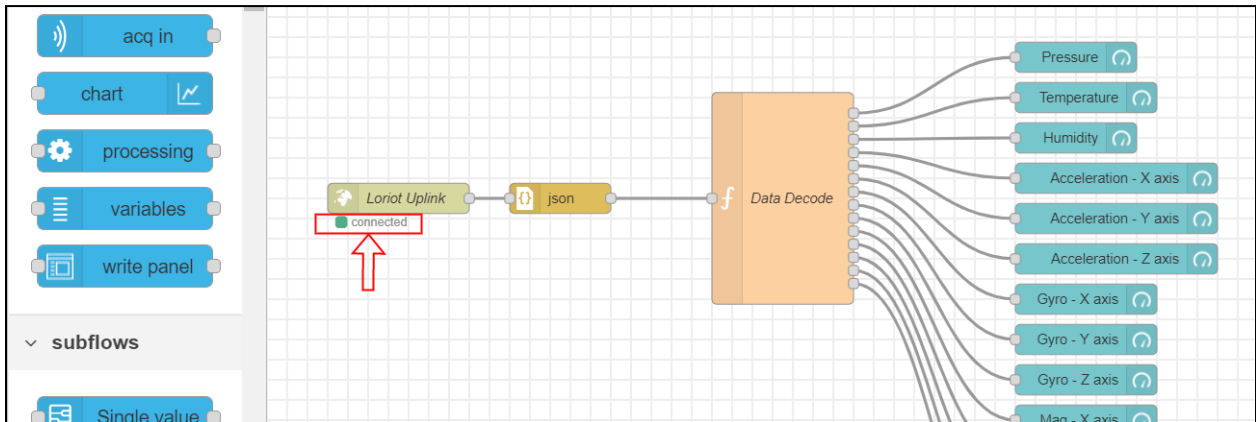
Figure 69. Deploy



## 4.4 Dashboard

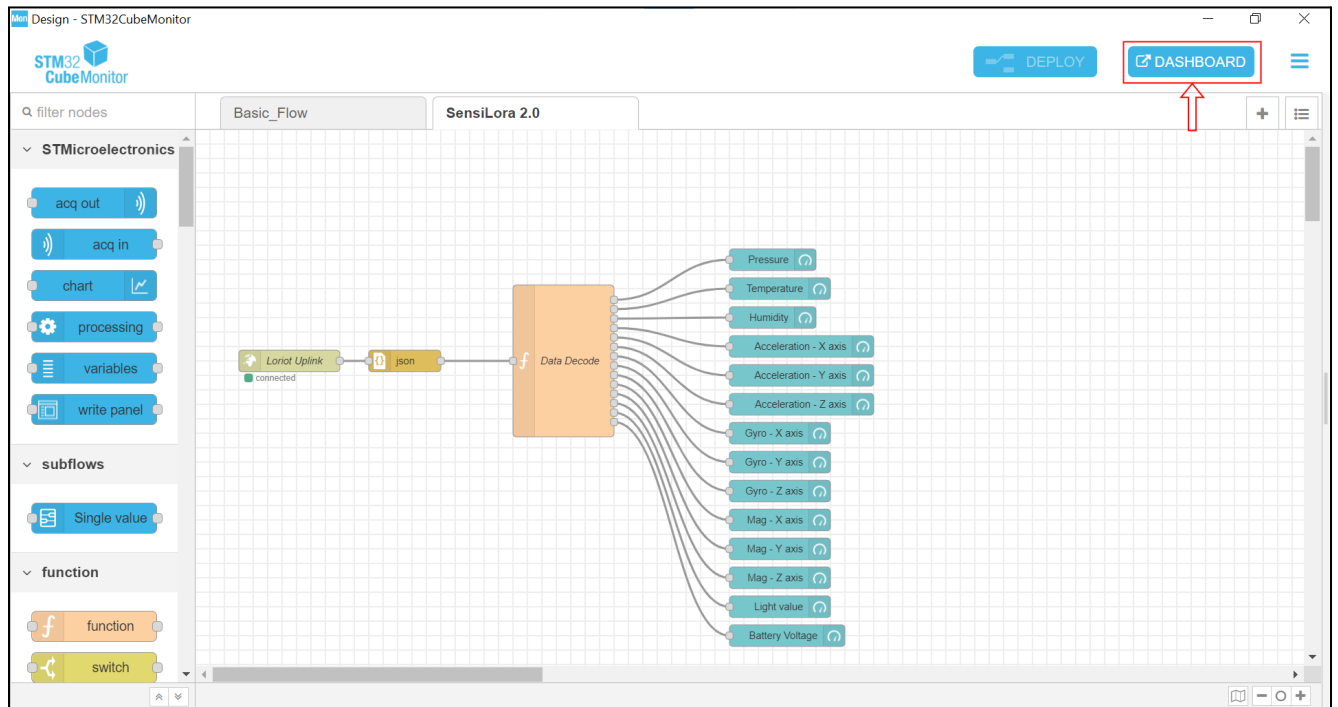
1. When we have changed the Server URL to the necessary and their status should be **connected** (Figure 70).

**Figure 70. Status Lorient**



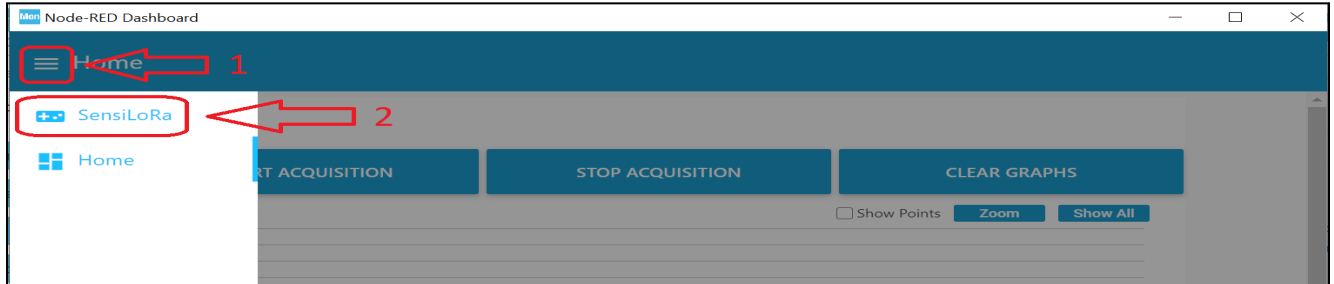
2. Click the **DASHBOARD** (Figure 71).

**Figure 71. Go to the Dashboard**



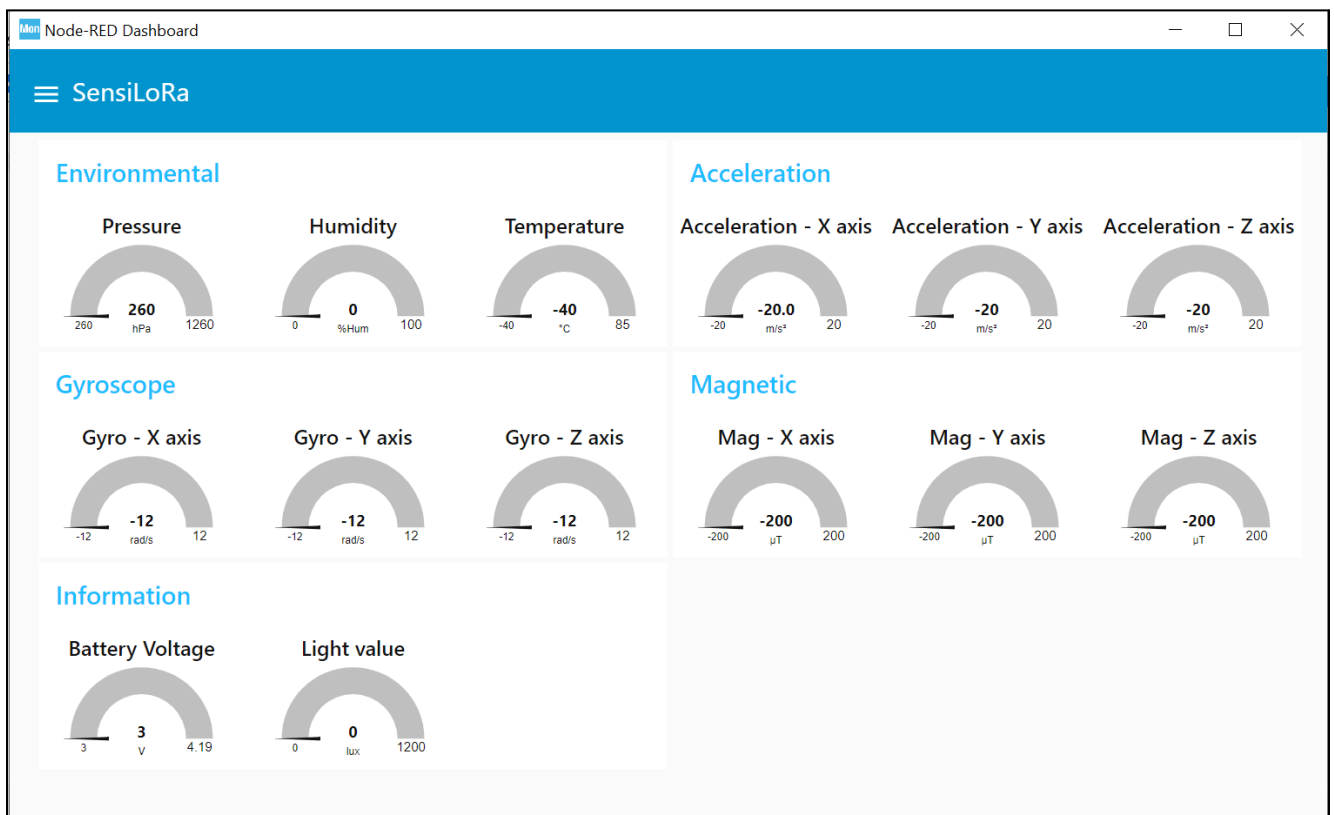
3. If several projects are open, then we need to go to the tab of our project, for this we click on the selection project (step 1) and then click on **SensiLoRa** (step 2). This action is illustrated in Figure 72.

**Figure 72. Selection of a project**



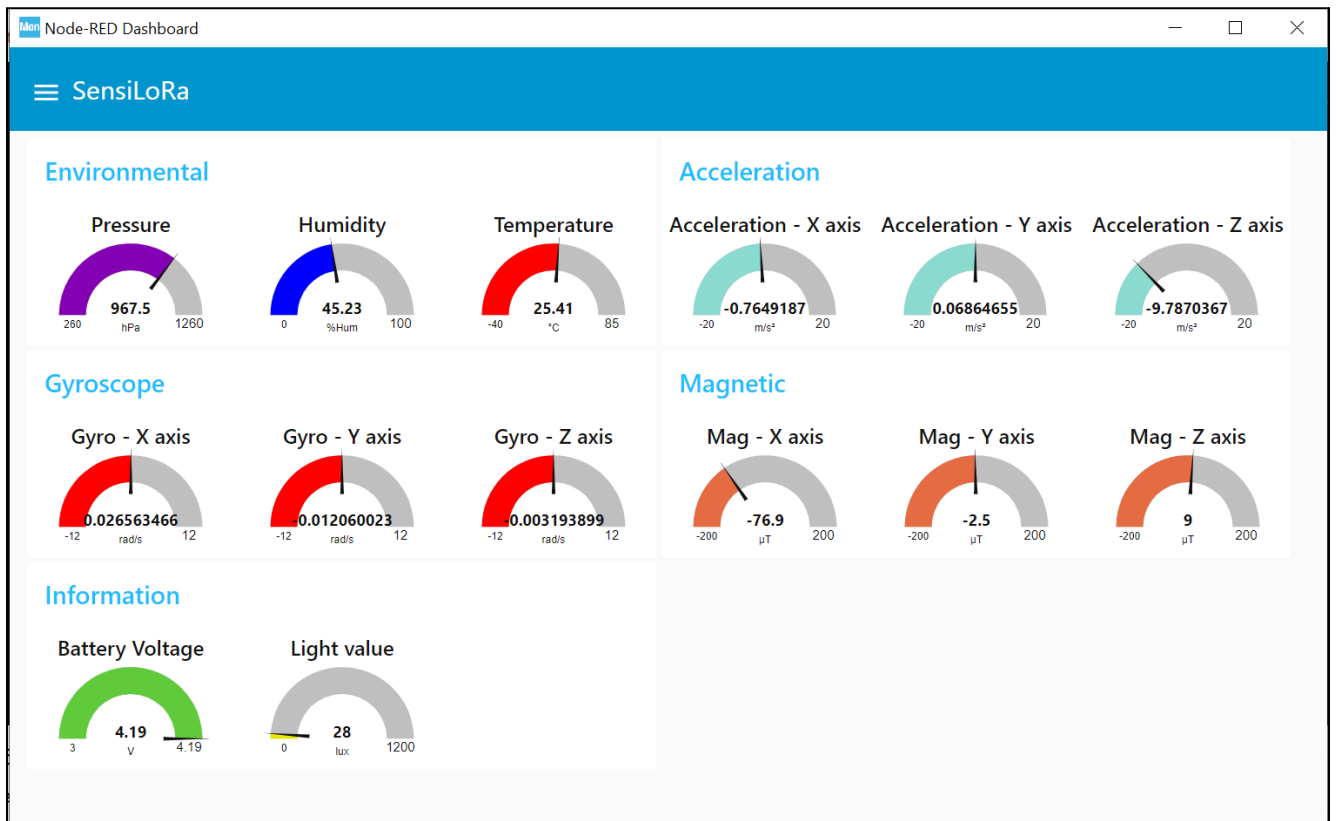
4. After selecting the project, we should see a window (Figure 73).

**Figure 73. Dashboard SensiLora**



5. When the data is sent by SensiLoRa 2.0 to the server Lorient, we will see the value of the sensors (Figure 74).

Figure 74. Data with sensors

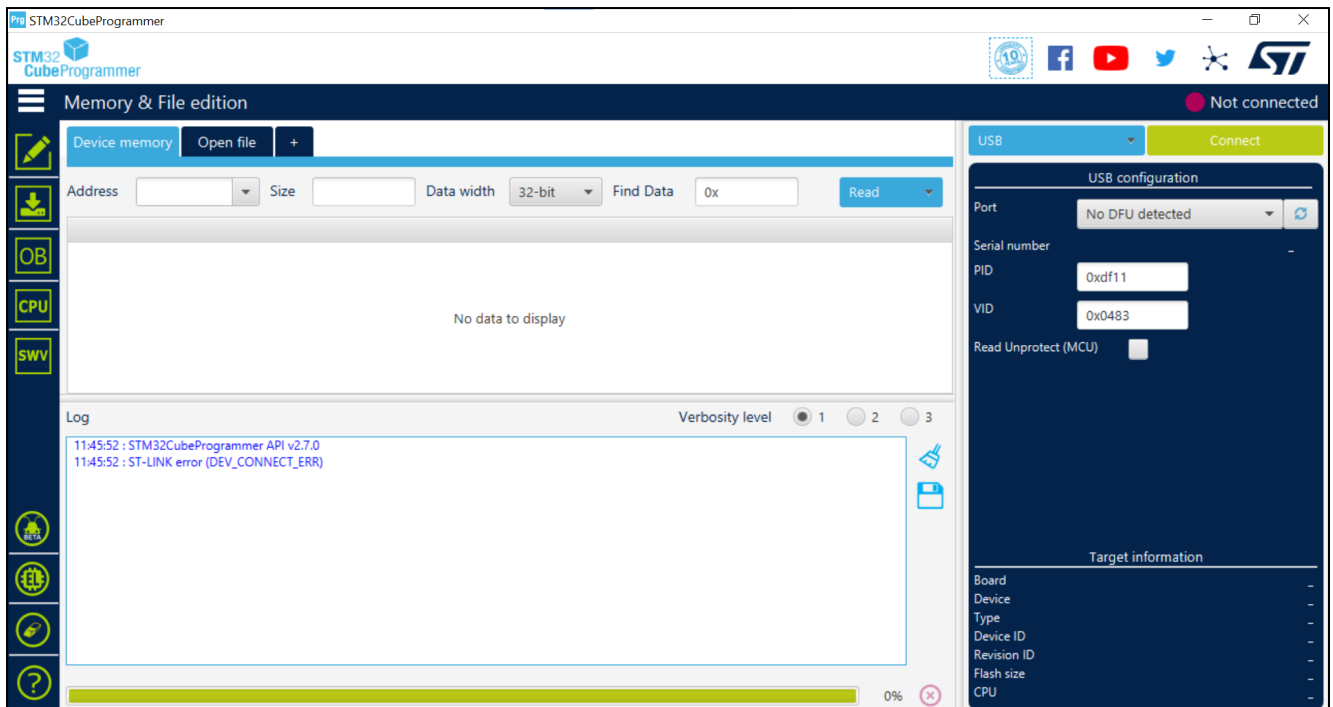


## 5 Flashing SensiLoRa 2.0

### 5.1 Install STM32CubeProgrammer

1. Download and install STM32CubeProgrammer from the ST site at this link: [STM32CubeMonitor](#) (Figure 75). There are several versions of the firmware, which differ in the operating frequencies of the LoRa, so pay attention to the name of the firmware, the operating frequency is indicated there. Download the firmware: ([Firmware SensiLoRa 2.0](#)).

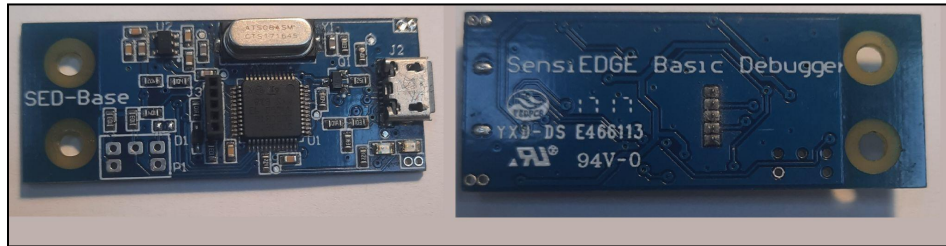
**Figure 75. STM32CubeProgrammer**



## 5.2 Flashing with SensiEdge Basic Debugger

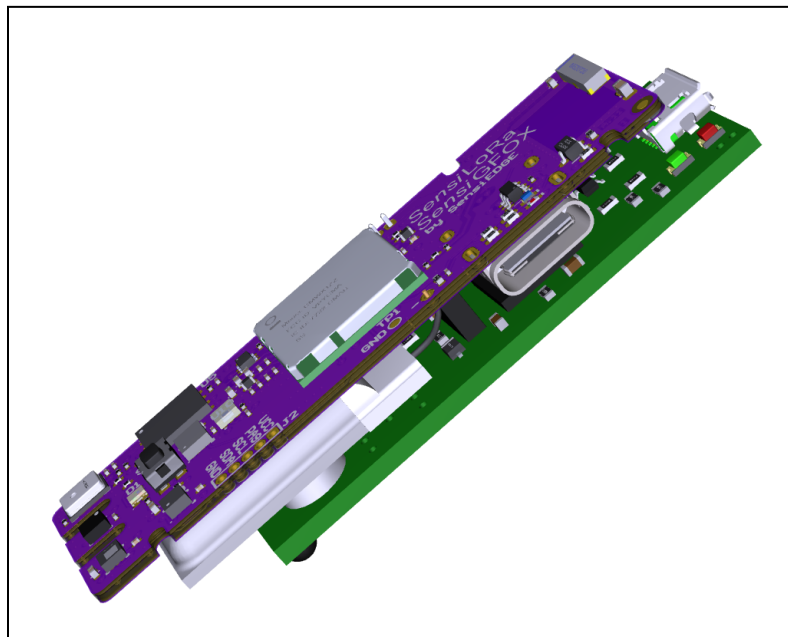
1. For the programming SensiLoRa 2.0 use the programmer SensiEdge Basic Debugger (Figure 76), if you don't have one, then go to [4.3 Flashing via USB Type-c](#).

**Figure 76. SensiEdge Basic Debugger**



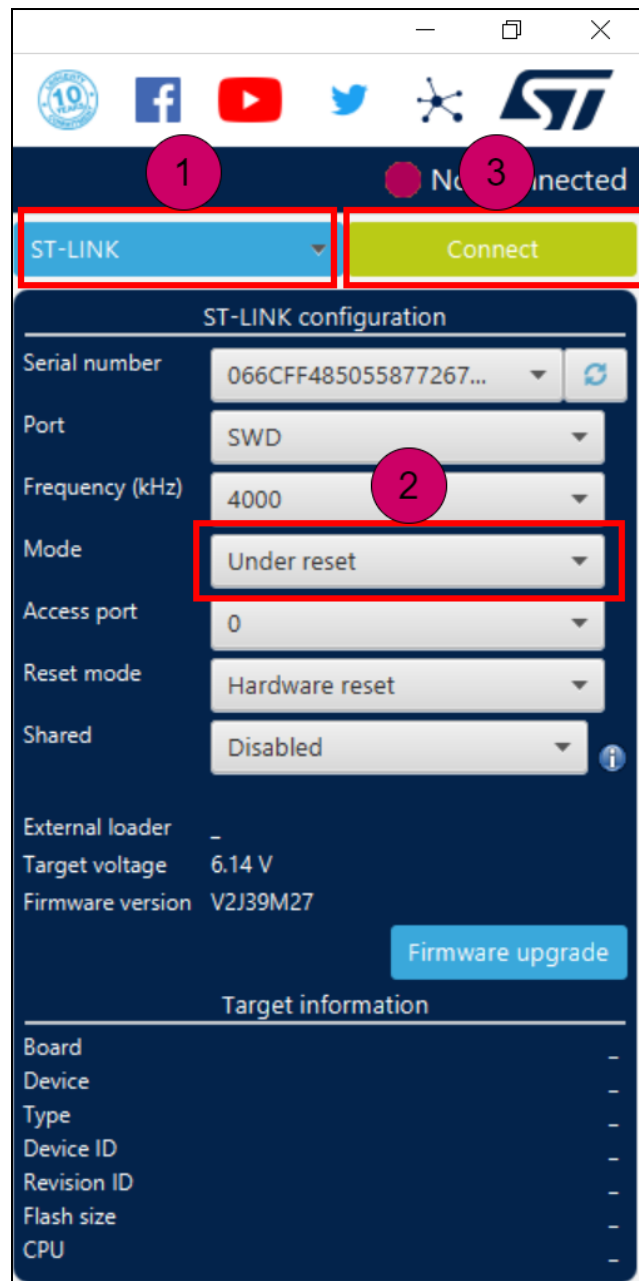
2. Connect the SensiLoRa 2.0 to the programmer SensiEdge Basic Debugger (Figure 77) and then connect the USB to the programmer.

**Figure 77. Connect to programmer**



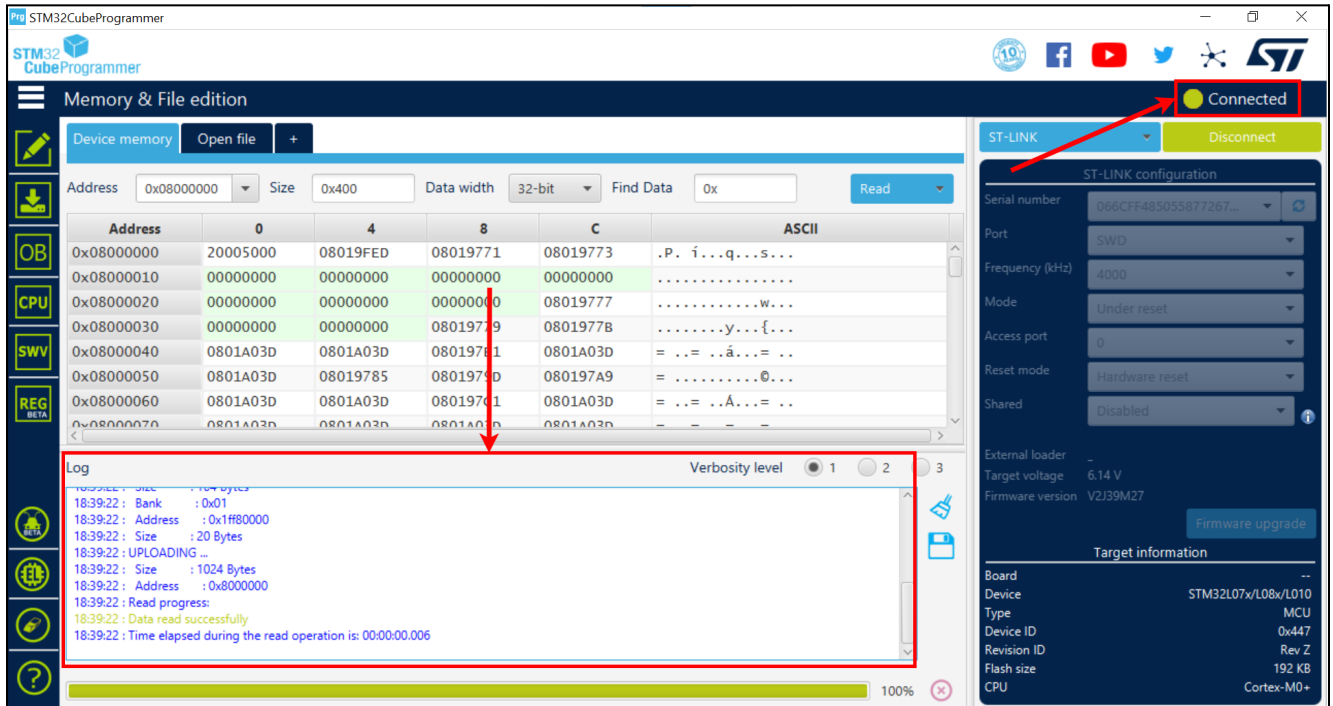
3. Open the program STM32CubeProgrammer and select the **ST\_LINK** (step 1), in **Mode** select **Under reset** (step 2) and then click on **Connect** (step 3). This action is illustrated in Figure 78.

**Figure 78. Connect to SensiLoRa 2.0**



4. If the connection was successful, then we should see information about the controller and status must be **Connected**. This action is illustrated in Figure 79.

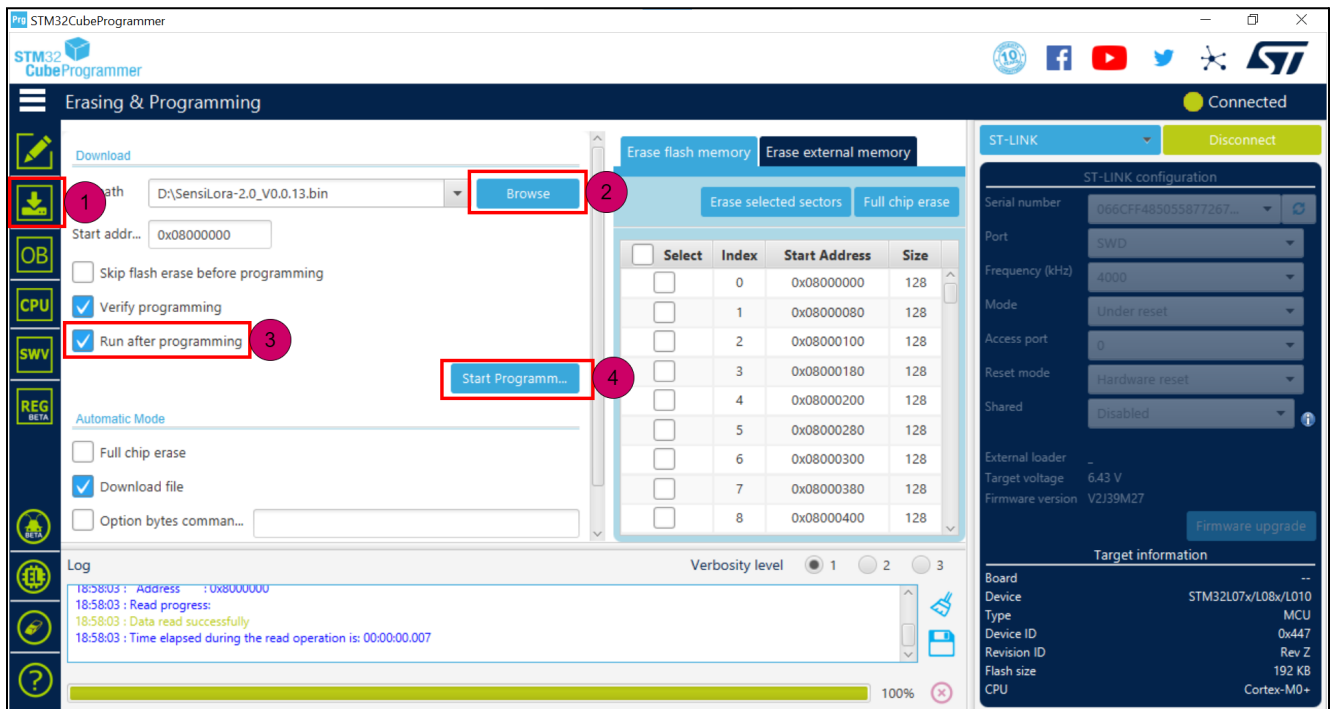
**Figure 79. Connect successfully**



5. After successfully connecting to the controller, select the tab **Erasing & Programming** (step 1) then click on the button **Browse** (step 2) a window will open where we have to specify the firmware file. Where to get the firmware file is described in [4.1 Install STM32CubeProgrammer](#). Check the box for **Run after programming** (step 3) and click **Start Programm...** (step 4). This action is illustrated in Figure 80.

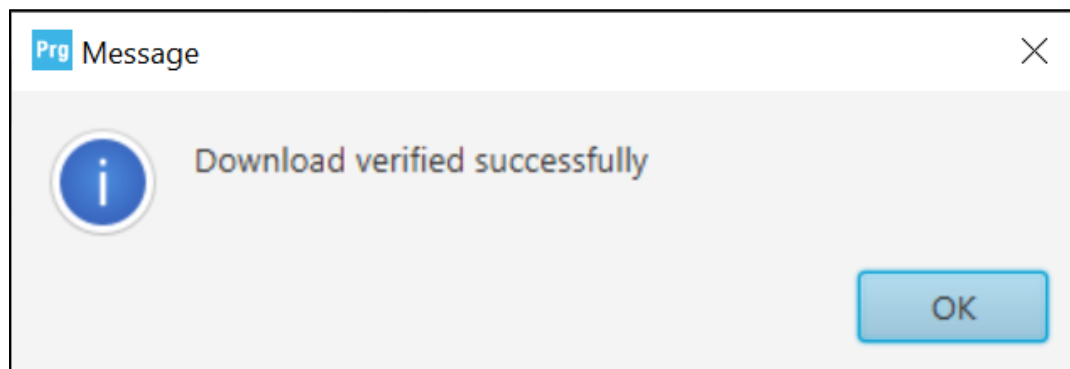


**Figure 80. Programming SensiLoRa 2.0**



6. After successfully loading the firmware, we should see the message Download verified successfully (Figure 81).

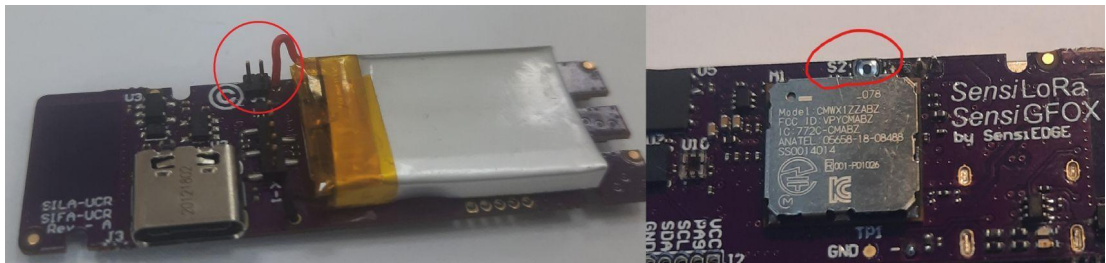
**Figure 81. Successful programming**



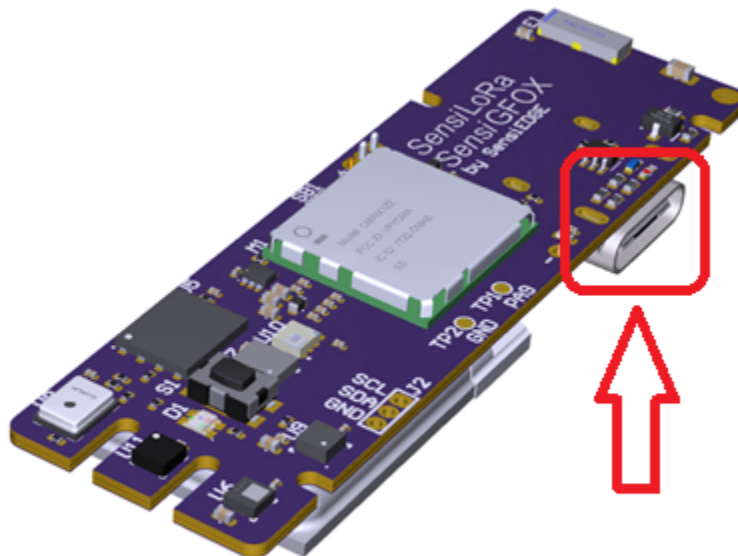
### 5.3 Flashing via USB Type-c

1. For flashing we will use such a program STM32CubeProgramming. First, we must disconnect the battery by disconnecting the jumper **J4** (Figure 82), then we must hold down button **S2** (Figure 82) and connect the cable **USB Type-c** (Figure 83) and after a couple of seconds we release the button, and the board enters the programming mode.

**Figure 82. Jumper J4 and Button S2**

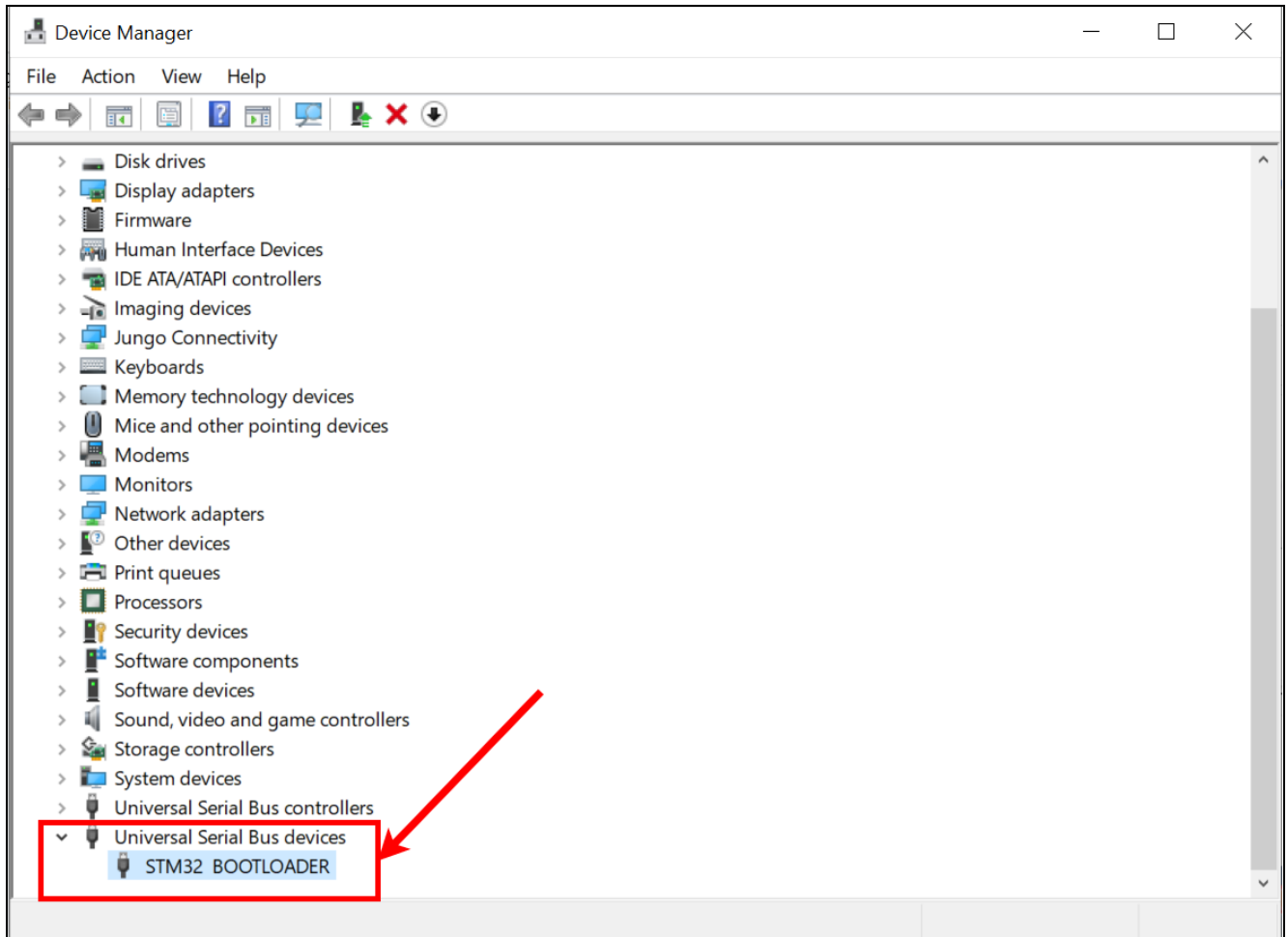


**Figure 83. Connect USB**



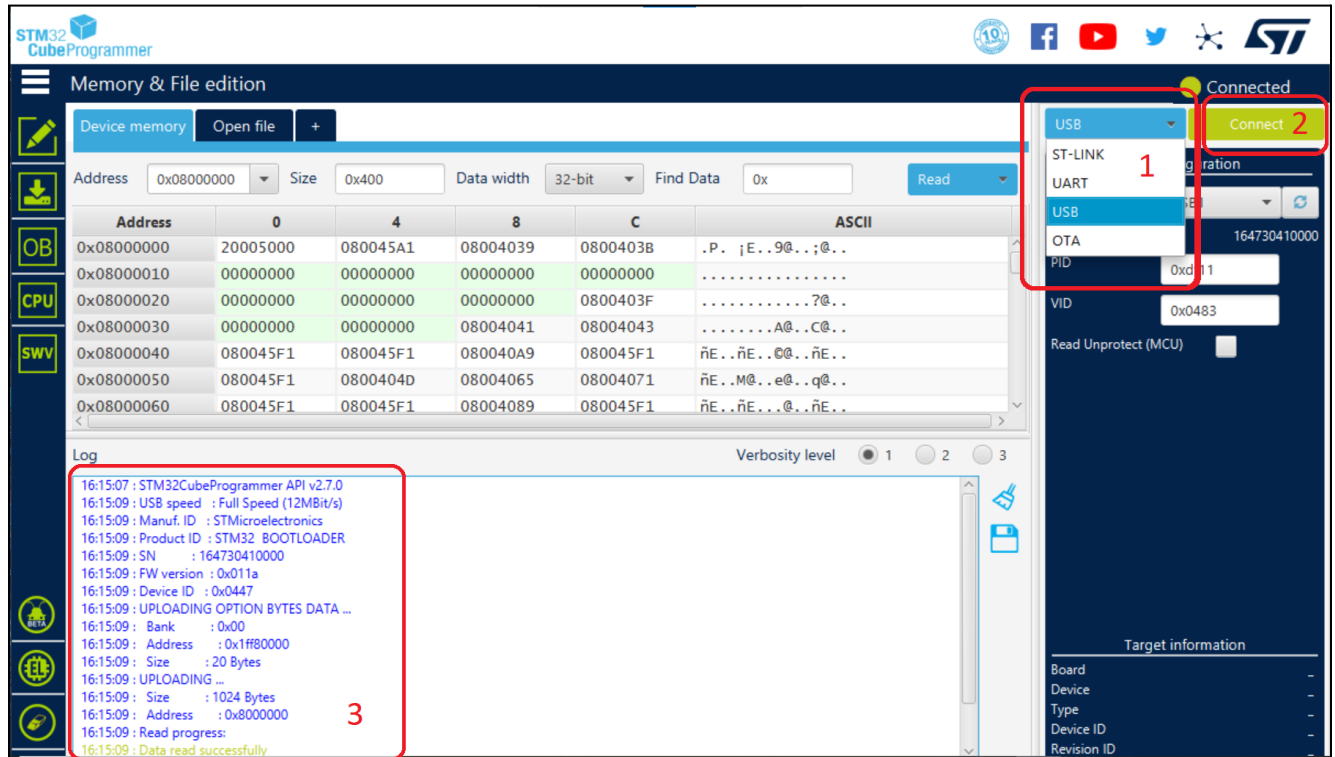
2. In Device Manager should appear STM32 BOOTLOADER (Figure 84). If this does not happen, repeat step 1.

**Figure 84. STM32 BOOTLOADER**



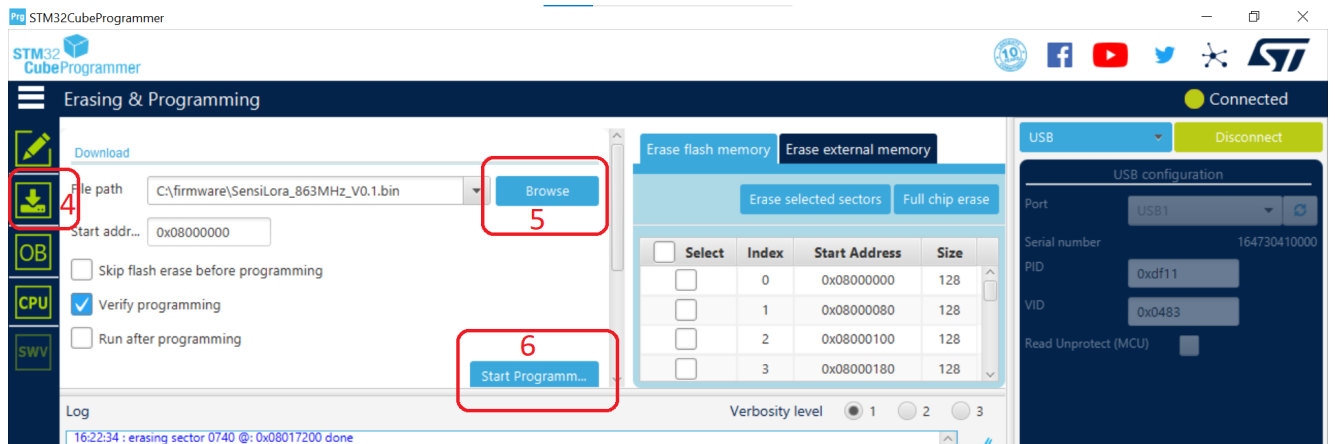
3. Open the program STM32CubeProgrammer and select the **USB** (step 1) and then click on **Connect** (step 2) and if the connection was successful, then we should see information about the controller (step 3). This action is illustrated in Figure 85.

Figure 85. Connect via USB



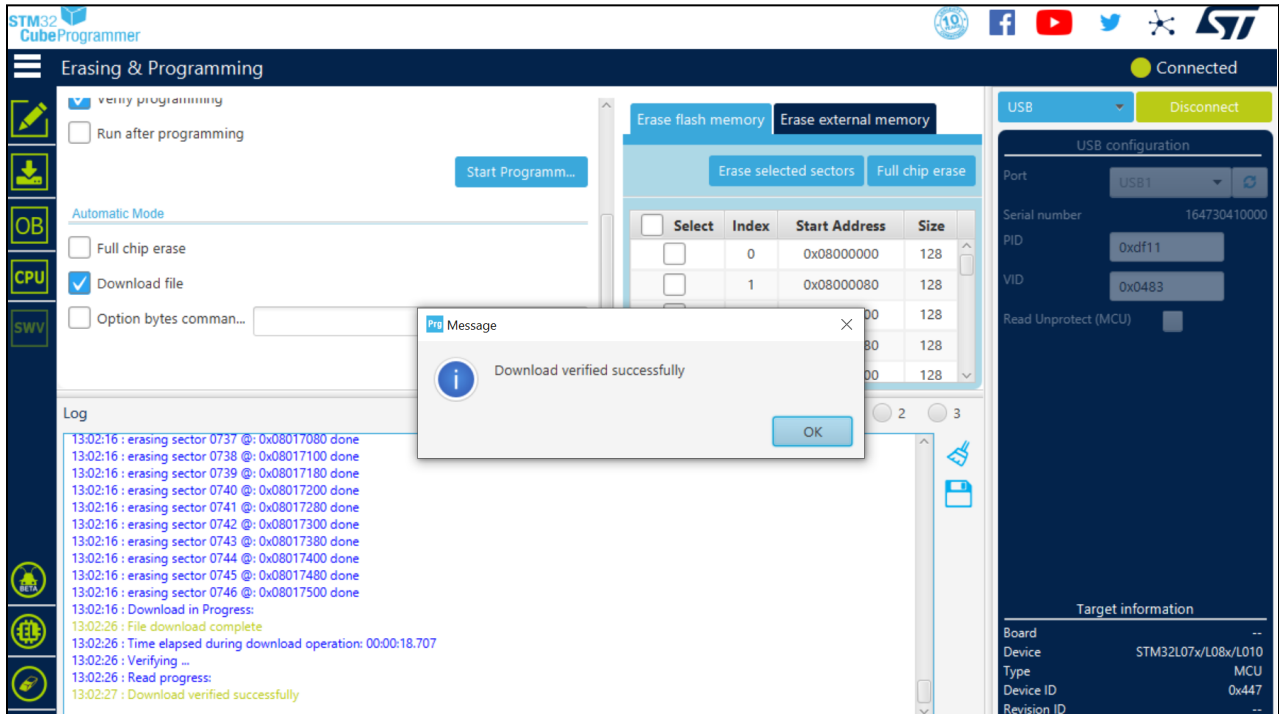
4. After successfully connecting to the controller, select the tab **Erasing & Programming** (step 4) then click on the button **Browse** (step 5) a window will open where we have to specify the firmware file. Where to get the firmware file is described in [4.1 Install STM32CubeProgrammer](#). After selecting the firmware file, press **Start Programm...**. This action is illustrated in Figure 86.

Figure 86. Programming via USB



5. After successfully loading the firmware, we should see the message Download verified successfully (Figure 87). After that, you can disconnect the device from the computer and return the jumper **J4**.

**Figure 87. Successful programming**

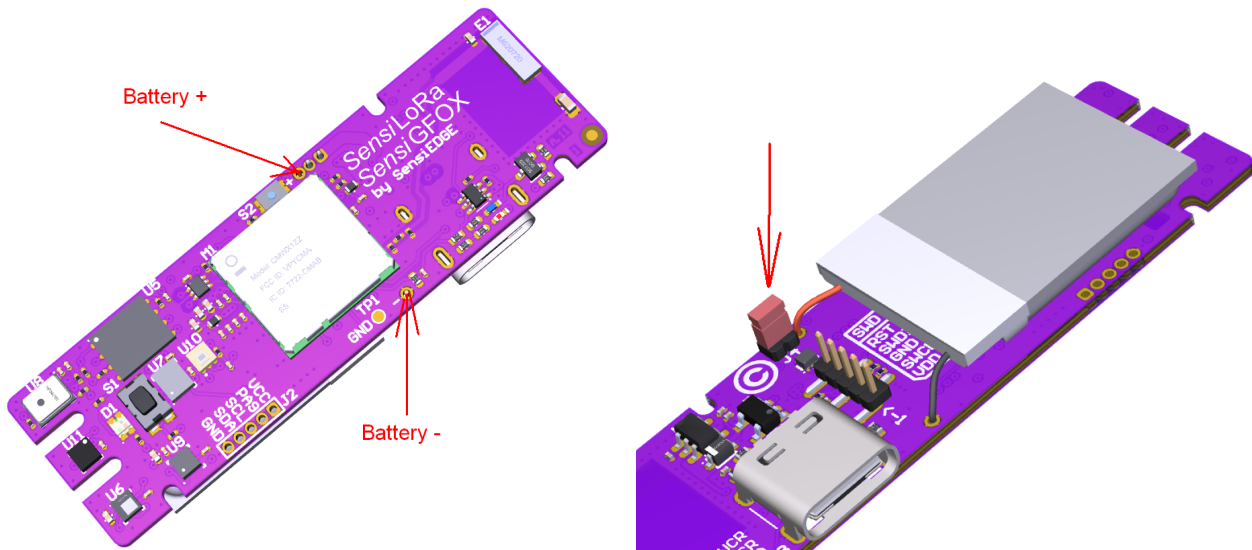


## 6 Battery power

### 6.1 Overview

1. SensiLoRa 2.0 integrating **SILA-UCR** (LoRa) and **SIFA-UCR** (Sigfox). Same hardware but different Software Firmware. Every board comes with a Rechargeable battery of 100mA. The battery is soldered but disconnected until the user will close the jumper. Install a jumper in J4 to operate the device on battery power (Figure 88).

**Figure 88. Battery power**



**Warning:** During USB charging additional heating is influence on Temperature and Pressure sensor. Be advised to use the measurement of those sensors only from battery operation.

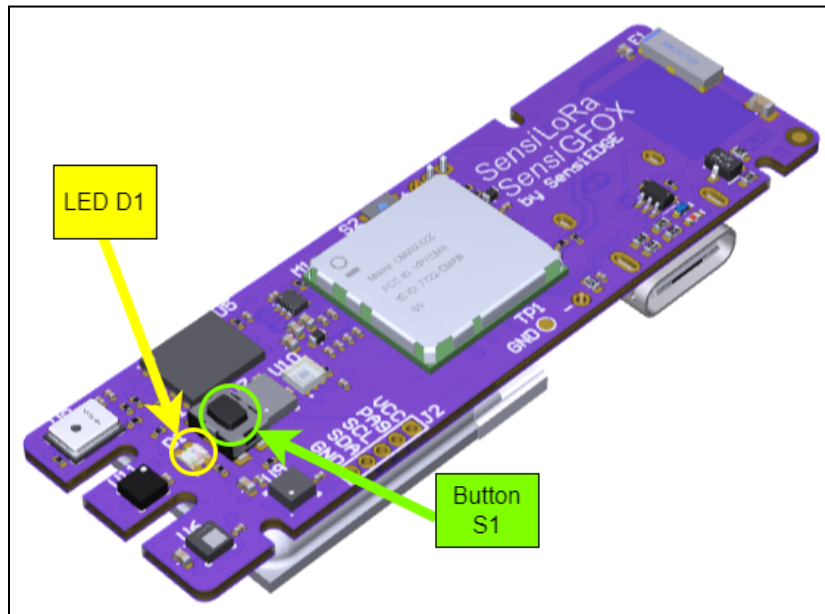
## 7 Turn on/off SensiLoRa 2.0

### 7.1 Turn on board

1. The SensiLoRa 2.0 board automatically turns on when power is applied.

2. To start the board after turning it off, you need to press the button **S1** (Figure 89) once and after that the **LED D1** (Figure 90) should light up in red for a short period.

**Figure 89. Button and LED placement**



### 7.2 Turn off board

1. to turn off the board, you need to hold down the button **S1** (at least 2 seconds) (Figure 89) until the **LED D1** turns green (Figure 89).

2. The green **LED D1** (Figure 89) should turn off after 2 seconds, after that the SensiLoRa 2.0 board goes into deep sleep and stops sending data to the LoRa server.

3. In sleep mode, the SensiLoRa 2.0 device consumes minimal power from the battery. A fully charged battery will last for 30 days. To completely de-energize the SensiLoRa 2.0 board, you need to disconnect the battery by removing the jumper from the jumper **J4**.



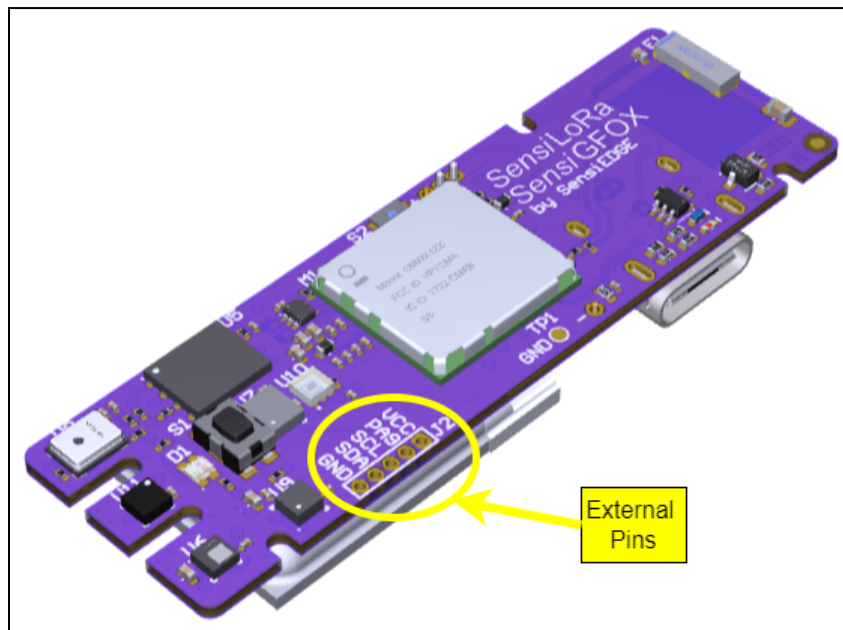
## 8 External pins

### 8.1 Overview

1. The SensiLoRa 2.0 board has a connector **J2** for external connection (Figure 90), it has such pins:

- **VCC** - 3.0 volt supply
- **PA9** - UART TX, for debug information
- **SCL** - the clock signal for I2C
- **SDA** - the data signal for I2C
- **GND** - ground

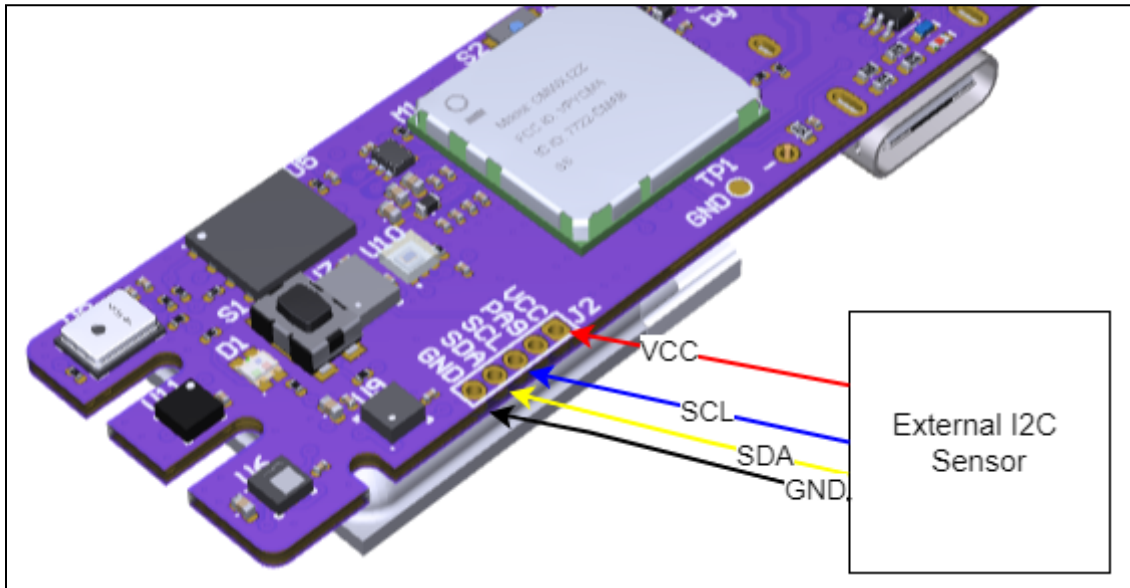
**Figure 90. External Pins**



### 8.2 External I2C

1. To connect an external sensor with an interface I2C for the SensiLoRa 2.0, you need to connect the sensor, as done in (Figure 91).

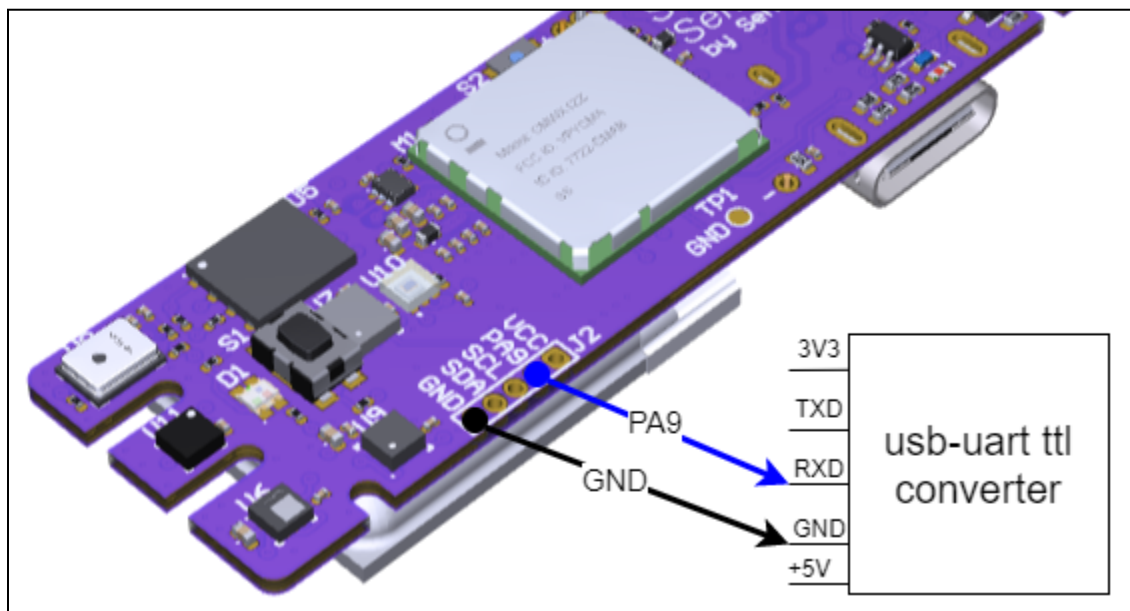
**Figure 91. Connect Sensor**



### 8.3 Debug information PA9 pin

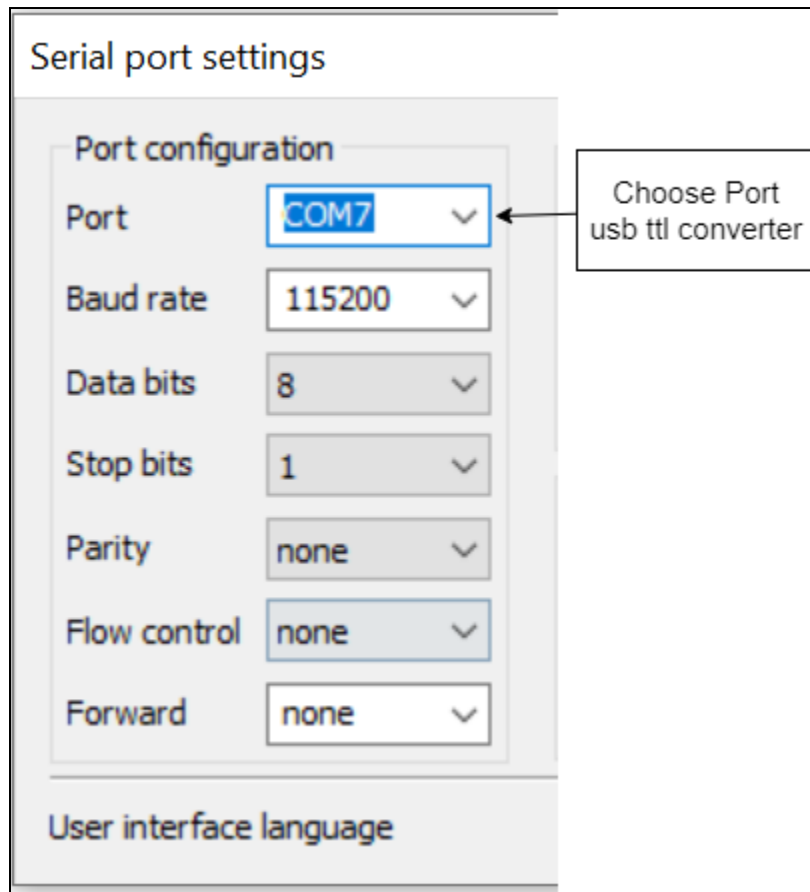
1. To see the debug information you need to use a **usb-uart ttl converter** and connect it to the SensiLoRa 2.0, as shown in the (Figure 92).

**Figure 92. Button and LED placement**



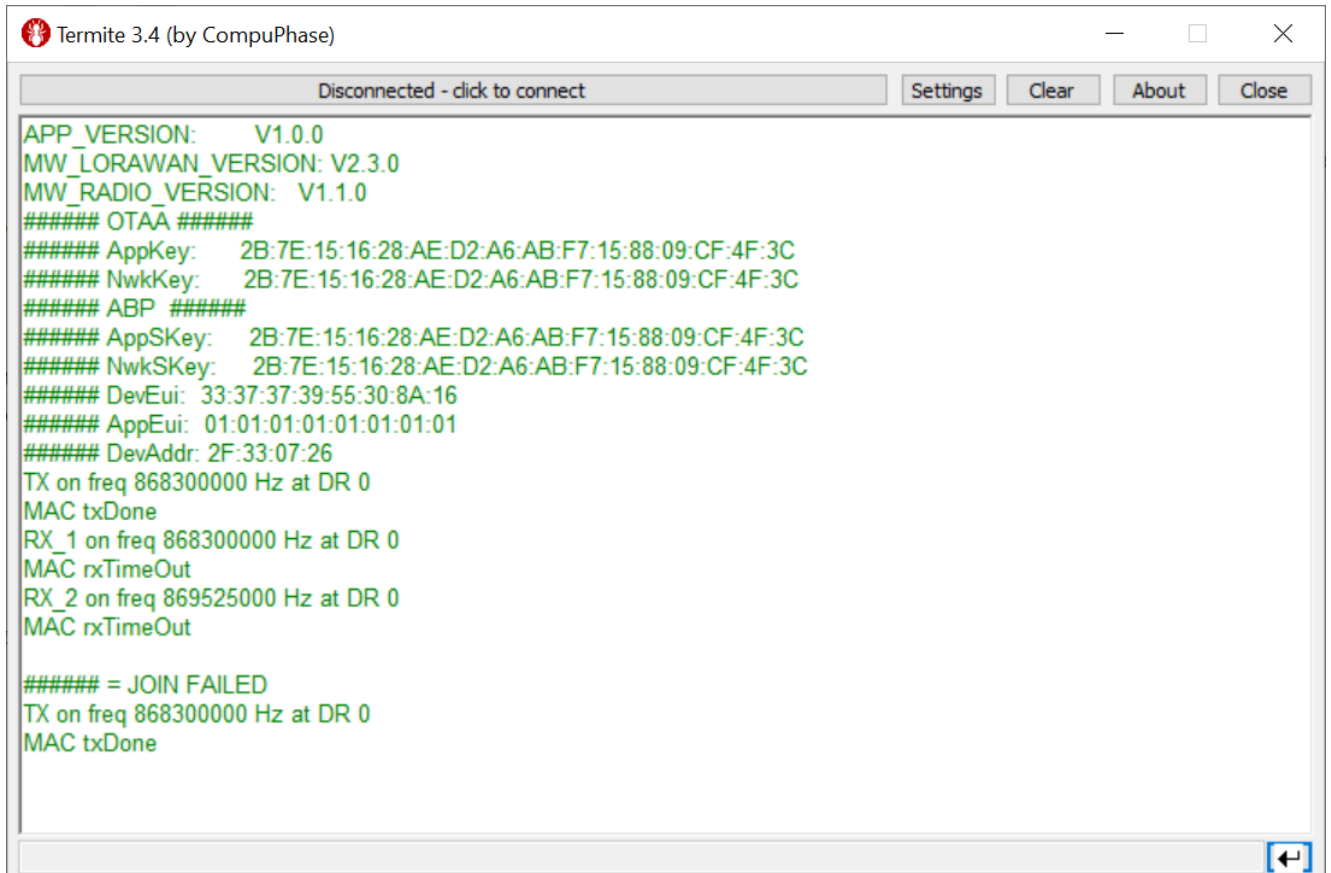
2. Any Terminal can be used to display Debug information. In the **Port settings** in the Terminal, select the **USB TTL converter port** and other settings as in the (Figure 93), then open the port.

**Figure 93. Port Settings**



3. When the board starts, the output of the information shown in the (Figure 94) will begin. Also here you can see the keys: **AppKey, DevEui and JoinEui(AppEui)**, that are used to connect the device to the LoRa server.

**Figure 94. Debug Information**



```
Termite 3.4 (by CompuPhase)
Disconnected - click to connect  Settings  Clear  About  Close

APP_VERSION:    V1.0.0
MW_LORAWAN_VERSION: V2.3.0
MW_RADIO_VERSION: V1.1.0
##### OTAA #####
##### AppKey:   2B:7E:15:16:28:AE:D2:A6:AB:F7:15:88:09:CF:4F:3C
##### NwkKey:   2B:7E:15:16:28:AE:D2:A6:AB:F7:15:88:09:CF:4F:3C
##### ABP #####
##### AppSKey:  2B:7E:15:16:28:AE:D2:A6:AB:F7:15:88:09:CF:4F:3C
##### NwkSKey:  2B:7E:15:16:28:AE:D2:A6:AB:F7:15:88:09:CF:4F:3C
##### DevEui:   33:37:37:39:55:30:8A:16
##### AppEui:   01:01:01:01:01:01:01:01
##### DevAddr:  2F:33:07:26
TX on freq 868300000 Hz at DR 0
MAC txDone
RX_1 on freq 868300000 Hz at DR 0
MAC rxTimeOut
RX_2 on freq 869525000 Hz at DR 0
MAC rxTimeOut

##### = JOIN FAILED
TX on freq 868300000 Hz at DR 0
MAC txDone
```